



STANDARD





CONFLUO STANDARD

SHAPE: Square and angular

USAGE: Private bathrooms
Bathrooms in the hotels, hospitals, fitness centers, saunas, spas, swimming pools
Commercial kitchens
Supermarkets
Restaurants
Airports
Glazed terraces, etc.

DETAILS: Square and angular shape, small frame height, stainless steel, adjustable to the angle, modern design, functionality

SIZE: Minimum height of the drain (all bases, except for the S base): 92 mm
Minimum height of the drain with S base: 84 mm

FEATURES:

- The mechanism of the drain itself is thinner and takes up little space under the floor
- Easy to install, adaptable to the needs because of the moving parts
- Sound isolated
- The model is characterized by low height of mechanism
- Possibility of application of Modern solutions with a classic look
- High flow
- Possibility to connect more sinks into one drain (up to 3 sinks)
- Drain is modular - each element of the superstructure corresponds to each base, allowing easy adaptation to various needs of the specific project
- A simple model, with good features and safety systems
- Created from quality materials with a high level of system security

SPECIAL ACCESSORIES FOR CONFLUO DRAINS:

- Grid for hair
- Irreversible valve (to prevent the return of foam, water, odor)
- Siphon inserted to block the odor

NEW S ULTRA LOW BASE

The lowest base with exit Ø50

Lower installation height

Improved water flow

The new streamlined design

MINIMAL INSTALLATION HEIGHT	MAXIMAL FLOW
↓ 51 mm	↓↓↓ 48 L/m



HEIGHTS AND FLOW RATES

MAXIMAL FLOW
↓↓↓
49 L/mm

BASE HEIGHT
76 mm



MAXIMAL FLOW
↓↓↓
49 L/mm

BASE HEIGHT
76 mm



MAXIMAL FLOW
↓↓↓
49 L/mm

BASE HEIGHT
76 mm



MAXIMAL FLOW
↓↓↓
49 L/mm

BASE HEIGHT
76 mm



MAXIMAL FLOW
↓↓↓
49 L/mm

BASE HEIGHT
68 mm



MAXIMAL FLOW
↓↓↓
49 L/mm

BASE HEIGHT
51 mm



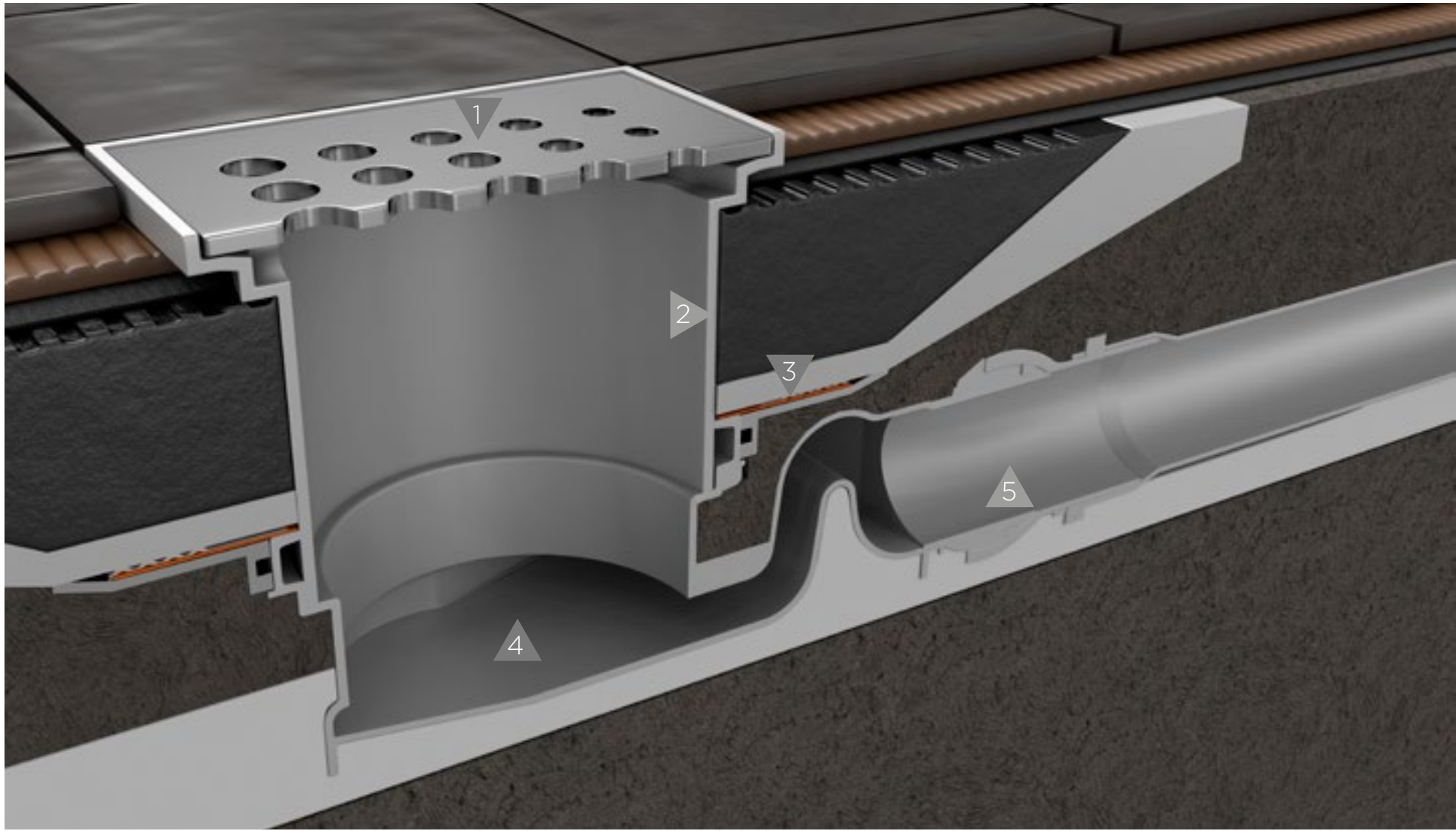

CROSS-SECTION OF STANDARD DRAIN

- 1_ Grid of a drain
- 2_ Carrier of grid
- 3_ Tin flange for hydro isolation and hoop for hydro isolation
between which sealing collar is embedded
- 4_ Base of drain
- 5_ Output Ø50

GRID DESIGN

CONFLUO SQUARE



CONFLUO TIDE



10 year warranty on grids CLASS K3 Maximum allowed up to 300 kg	Type of steel AISI 304 Optional AISI 316
--	---

CONFLUO DROPS

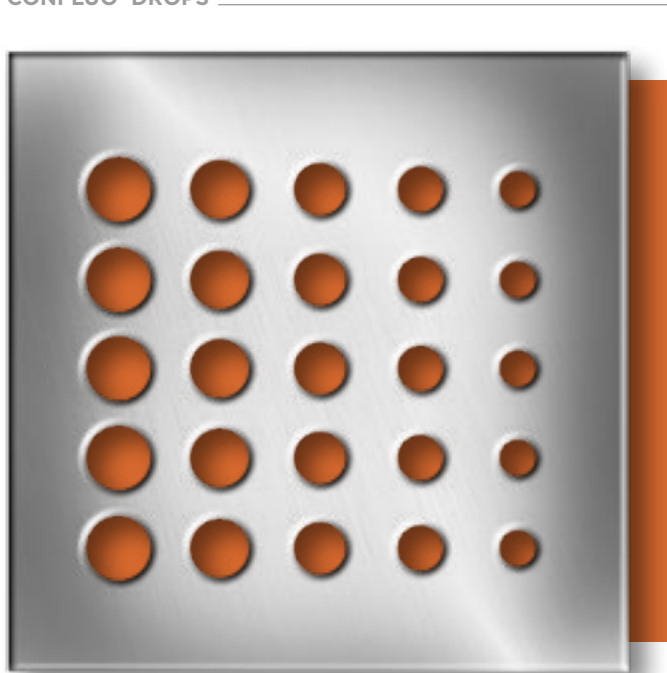

CONFLUO ANGLE





ADVANTAGES OF THE MATERIAL THAT DRAIN IS MADE OF

- Resistance to external influences
- High compressive strength
- High resistance to impact
- High temperature resistance (short-term)

SETS OF DRAINS CONFLUO STANDARD

TIDE 1	TIDE 2	TIDE 3	TIDE 4	VERTICAL TIDE
Article number 13000001	Article number 13000002	Article number 13000003	Article number 13000004	Article number 13000018

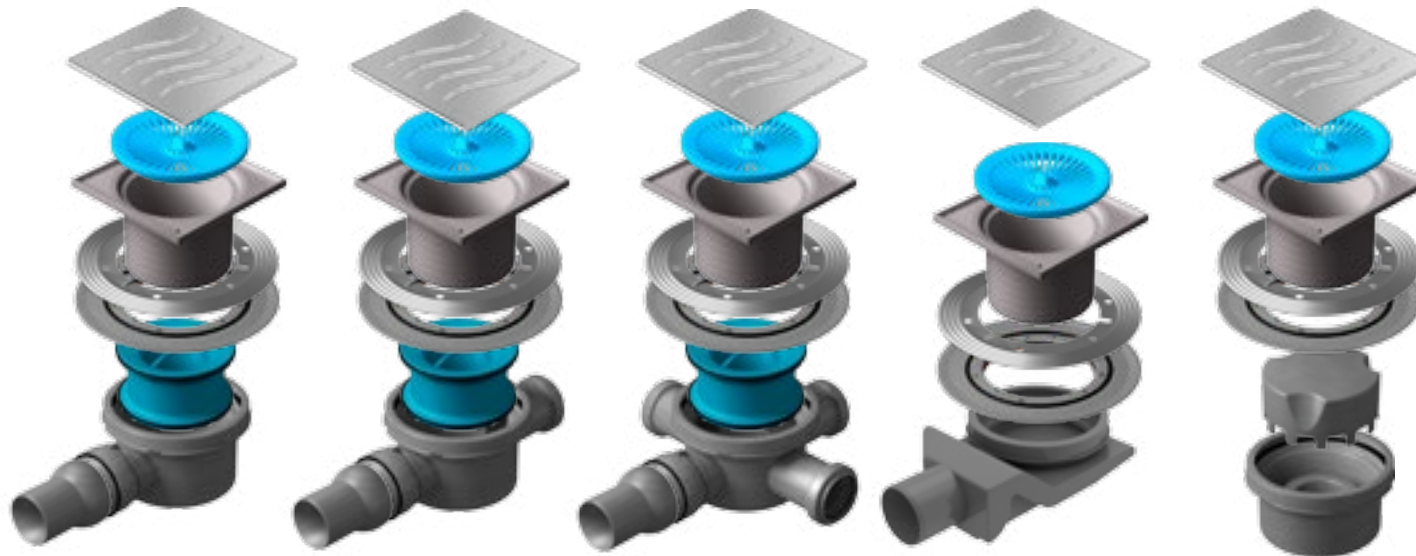

FLOW RATE
↓↓↓
48 L/mm

MINIMAL HEIGHT
↕ 64 mm

FLOW RATE
↓↓↓
48 L/mm

MINIMAL HEIGHT
↕ 64 mm

FLOW RATE
↓↓↓
48 L/mm

MINIMAL HEIGHT
↕ 64 mm

FLOW RATE
↓↓↓
48 L/mm

MINIMAL HEIGHT
↕ 71 mm

FLOW RATE
↓↓↓
48 L/mm

MINIMAL HEIGHT
↕ 69 mm

 150mm

150mm

10 year warranty on grids
CLASS K3
Maximum allowed up to 300 kg

Type of steel
AISI 304
Optional
AISI 316

OPTIONAL



IRRETRIEVABLE VALVE

Article number
13500002



SOCKET

Article number
13500003



SETS OF DRAINS CONFLUO STANDARD

DROPS 1	DROPS 2	DROPS 3	DROPS 4	VERTICAL DROPS
Article number 13000009	Article number 13000010	Article number 13000011	Article number 13000012	Article number 13000020



FLOW RATE
↓↓↓
48 L/mm

MINIMAL HEIGHT
↕ 64 mm

FLOW RATE
↓↓↓
48 L/mm

MINIMAL HEIGHT
↕ 64 mm

FLOW RATE
↓↓↓
48 L/mm

MINIMAL HEIGHT
↕ 64 mm

FLOW RATE
↓↓↓
48 L/mm

MINIMAL HEIGHT
↕ 71 mm

FLOW RATE
↓↓↓
48 L/mm

MINIMAL HEIGHT
↕ 69 mm

150mm

150mm

10 year warranty on grids
CLASS K3
Maximum allowed up to 300 kg

Type of steel
AISI 304
Optional
AISI 316

OPTIONAL

IRRETRIEVABLE VALVE

Article number
13500002

SOCKET

Article number
13500003



SQUARE GRID

SETS OF DRAINS CONFLUO STANDARD

SQUARE 1	SQUARE 2	SQUARE 3	SQUARE 4	VERTICAL SQUARE
Article number 13000005	Article number 13000006	Article number 13000007	Article number 13000008	Article number 13000019



FLOW RATE
↓↓↓
48 L/mm

MINIMAL HEIGHT
↕ 64 mm

FLOW RATE
↓↓↓
48 L/mm

MINIMAL HEIGHT
↕ 64 mm

FLOW RATE
↓↓↓
48 L/mm

MINIMAL HEIGHT
↕ 64 mm

FLOW RATE
↓↓↓
48 L/mm

MINIMAL HEIGHT
↕ 71 mm

FLOW RATE
↓↓↓
48 L/mm

MINIMAL HEIGHT
↕ 69 mm

150mm

150mm

10 year warranty on grids
CLASS K3
Maximum allowed up to 300 kg

Type of steel
AISI 304
Optional
AISI 316

OPTIONAL

IRRETRIEVABLE VALVE

Article number
13500002

SOCKET

Article number
13500003

YOUR BATHROOM ACCORDING TO YOUR TASTE

The new design of Confluo standard drains and even more installation options!





SETS OF DRAINS CONFLUO STANDARD

TIDE 1 MASK	TIDE 2 MASK	TIDE 3 MASK	TIDE 4 MASK	VERTICAL TIDE MASK
Article number 13000070	Article number 13000071	Article number 13000080	Article number 13000081	Article number 13000074

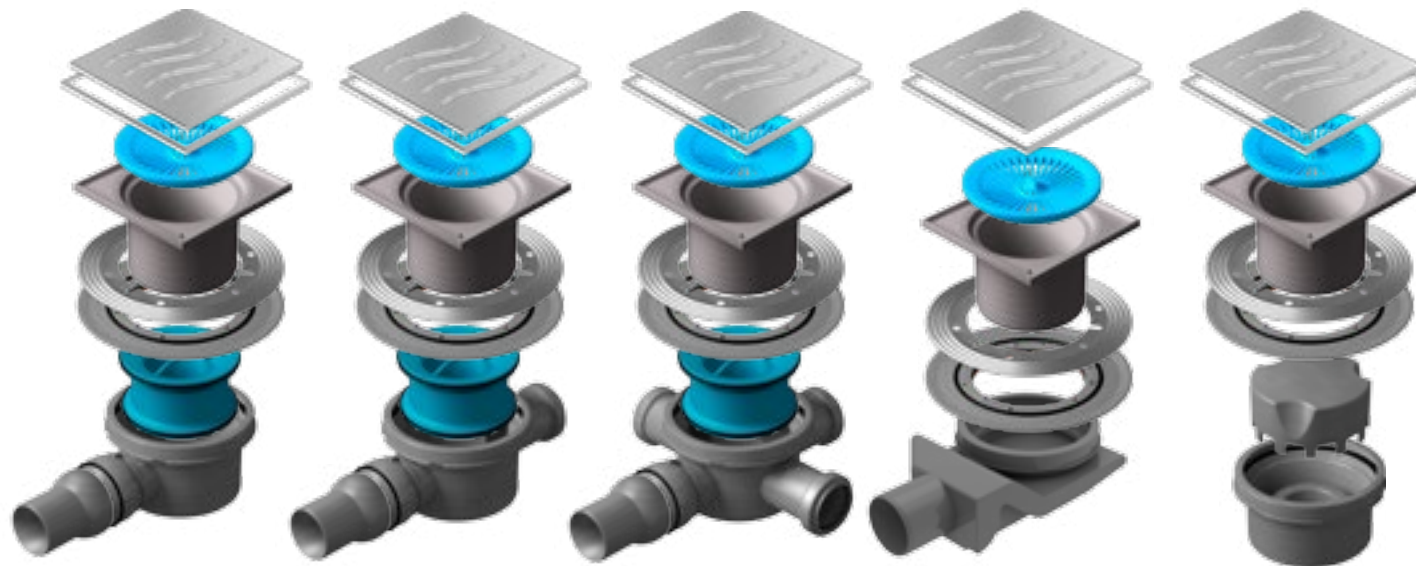

FLOW RATE
↓↓↓
48 L/mm

MINIMAL HEIGHT
↕ 64 mm

FLOW RATE
↓↓↓
48 L/mm

MINIMAL HEIGHT
↕ 64 mm

FLOW RATE
↓↓↓
48 L/mm

MINIMAL HEIGHT
↕ 64 mm

FLOW RATE
↓↓↓
48 L/mm

MINIMAL HEIGHT
↕ 71 mm

FLOW RATE
↓↓↓
48 L/mm

MINIMAL HEIGHT
↕ 69 mm

150mm

150mm

10 year warranty on grids

CLASS K3
Maximum allowed up to 300 kg

Type of steel
AISI 304
Optional
AISI 316

OPTIONAL



IRRETRIEVABLE VALVE

Article number
13500002



SOCKET

Article number
13500003







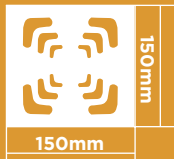

SETS OF DRAINS CONFLUO STANDARD

DROPS 1 MASK	DROPS 2 MASK	DROPS 3 MASK	DROPS 4 MASK	VERTICAL DROPS MASK	
Article number 13000072	Article number 13000077	Article number 13000078	Article number 13000079	Article number 13000075	 <p>150mm 150mm</p> <p>10 year warranty on grids CLASS K3 Maximum allowed up to 300 kg</p> <p>Type of steel AISI 304 Optional AISI 316</p>
					<p>OPTIONAL</p>  <p>IRRETRIEVABLE VALVE</p> <p>Article number 13500002</p>  <p>SOCKET</p> <p>Article number 13500003</p>
<p>FLOW RATE ↓↓↓ 48 L/mm</p> <p>MINIMAL HEIGHT ↕ 64 mm</p>	<p>FLOW RATE ↓↓↓ 48 L/mm</p> <p>MINIMAL HEIGHT ↕ 64 mm</p>	<p>FLOW RATE ↓↓↓ 48 L/mm</p> <p>MINIMAL HEIGHT ↕ 64 mm</p>	<p>FLOW RATE ↓↓↓ 48 L/mm</p> <p>MINIMAL HEIGHT ↕ 71 mm</p>	<p>FLOW RATE ↓↓↓ 48 L/mm</p> <p>MINIMAL HEIGHT ↕ 69 mm</p>	

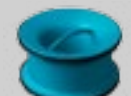

SETS OF DRAINS CONFLUO STANDARD

SQUARE 1 MASK	SQUARE 2 MASK	SQUARE 3 MASK	SQUARE 4 MASK	VERTICAL SQUARE MASK	
Article number 13000073	Article number 13000082	Article number 13000083	Article number 13000084	Article number 13000076	 <p>150mm 150mm</p> <p>10 year warranty on grids CLASS K3 Maximum allowed up to 300 kg</p> <p>Type of steel AISI 304 Optional AISI 316</p>
					<p>OPTIONAL</p>  <p>IRRETRIEVABLE VALVE</p> <p>Article number 13500002</p>  <p>SOCKET</p> <p>Article number 13500003</p>
<p>FLOW RATE ↓↓↓ 48 L/mm</p> <p>MINIMAL HEIGHT ↕ 64 mm</p>	<p>FLOW RATE ↓↓↓ 48 L/mm</p> <p>MINIMAL HEIGHT ↕ 64 mm</p>	<p>FLOW RATE ↓↓↓ 48 L/mm</p> <p>MINIMAL HEIGHT ↕ 64 mm</p>	<p>FLOW RATE ↓↓↓ 48 L/mm</p> <p>MINIMAL HEIGHT ↕ 71 mm</p>	<p>FLOW RATE ↓↓↓ 48 L/mm</p> <p>MINIMAL HEIGHT ↕ 69 mm</p>	



STANDARD GOLD DRAINS

Standard drains
gold plated with 24k gold
6 μ the thickness of the gold plating

SETS OF DRAINS CONFLUO STANDARD

TIDE 1 GOLD	Article No. 13000140	DROPS 1 GOLD	Article No. 13000148	SQUARE 1 GOLD	Article No. 13000144	VERTICAL TIDE GOLD	Article No. 13000163
TIDE 2 GOLD	13000141	DROPS 2 GOLD	13000149	SQUARE 1 GOLD	13000145	VERTICAL DROPSGOLD	13000164
TIDE 3 GOLD	13000142	DROPS 3 GOLD	13000150	SQUARE 1 GOLD	13000146	VERTICAL SQUARE GOLD	13000165
TIDE 4 GOLD	13000143	DROPS 4 GOLD	13000151	SQUARE 1 GOLD	13000147		

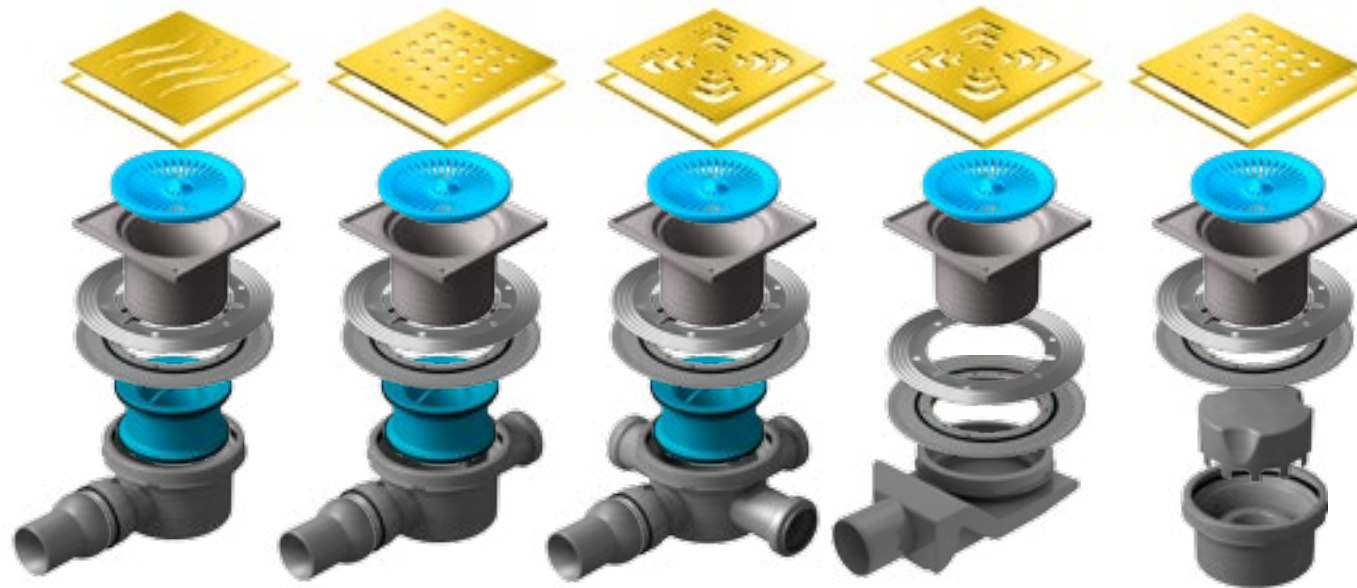

FLOW RATE
↓↓↓
48 L/mm

MINIMAL HEIGHT
↕ 64 mm

FLOW RATE
↓↓↓
48 L/mm

MINIMAL HEIGHT
↕ 64 mm

FLOW RATE
↓↓↓
48 L/mm

MINIMAL HEIGHT
↕ 64 mm

FLOW RATE
↓↓↓
48 L/mm

MINIMAL HEIGHT
↕ 71 mm

FLOW RATE
↓↓↓
48 L/mm

MINIMAL HEIGHT
↕ 69 mm

100mm
150mm

150mm
100mm

10 year warranty on grids
CLASS K3
Maximum allowed up to 300 kg

Type of steel
AISI 304
Optional
AISI 316

OPTIONAL

IRRETRIEVABLE VALVE

Article number
13500002

SOCKET

Article number
13500003



SETS OF DRAINS CONFLUO STANDARD

DRY 1	DRY 2	DRY 3	VERTICAL DRY
Article number 13000015	Article number 13000016	Article number 13000017	Article number 13000022



FLOW RATE
↓↓↓
48 L/mm

MINIMAL HEIGHT
↕ 64 mm

MAXIMAL FLOW
↓↓↓
48 L/mm

MINIMAL HEIGHT
↕ 64 mm

FLOW RATE
↓↓↓
48 L/mm

MINIMAL HEIGHT
↕ 64 mm

FLOW RATE
↓↓↓
48 L/mm

MINIMAL HEIGHT
↕ 69 mm

100mm

100mm

10 year warranty on grids
CLASS K3
Maximum allowed up to 300 kg

Type of steel
AISI 304
Optional
AISI 316

OPTIONAL



SOCKET

Article number
13500003