

 EVOLUTION
ELEGANCE COMES IN DETAILS













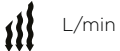

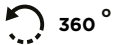
≡ EVO

Introduction

Evolution line of shower drains represents the result of 5 years constant exploring and following of the latest trends in industry worldwide. It is a combination of highest technical requirements, unique design & innovations represented in every model. The Range consists of more than 110 different products divided in 3 groups EVO Ultra Thin, EVO Line and EVO Unlimited. Go into the world of Evolution shower drains and be part of the next generation of bathroom drainage. Evolution shower drains are manufactured by Pestan company, Serbia.

Evo Icons

<p>1</p> 	<p>2</p> 	<p>3</p> 	<p>4</p> 
<p>Min. installation height</p> <p>Minimal construction height of drain, from bottom of base up to holder of grid.</p>	<p>Base diameter</p> <p>Diameter of horizontal base outlet.</p>	<p>Maximum flow rate</p> <p>Maximum flow rate with 20 cm threshold.</p>	<p>Unlimited design</p> <p>With set of parts who is coming in Unlimited box, client can make huge variety of shapes who fits almost any modern bathroom.</p>
<p>5</p> 	<p>6</p> 	<p>7</p> 	<p>8</p> 
<p>2 in 1 system</p> <p>Grid of drain can be turned and used both for stainless steel and ceramic finish.</p>	<p>Base rotation</p> <p>Base of drain can be rotated 360 degrees.</p>	<p>Guarantee</p> <p>10 years Guarantee.</p>	<p>Leveling of ceramic</p> <p>Model have system for leveling of ceramic from/to so client can have flexibility in choosing surface in bathroom.</p>
<p>9</p> 	<p>10</p> 	<p>11</p> 	<p>12</p> 
<p>Unltd leveling of ceramic</p> <p>Model have construction that allows installation of any surface so client have unlimited flexibility in choosing s urface in his bathroom.</p>	<p>Easy to clean</p> <p>Drain can be cleaned without removing grid so it makes it easy to clean.</p>	<p>ALS system</p> <p>Anti Leaking System represent combination of construction of drain and proper installation which allows all leaked and condensated water to go back to drain.</p>	<p>Unltd drain lenght</p> <p>Thanks to the universal solution lenght of drain can be adjusted to UNLIMITED lenght. Numbers describe distance between holder of grid and top of the grid, without adhesive for ceramic and hydro isolation.</p>
<p>13</p> 	<p>14</p> <p>AISI 304</p>	<p>15</p> <p>K3</p>	<p>16</p> 
<p>Unlimited flow rate</p> <p>With combination of appropriate parts, model can have unlimited flow rate because you can put as much as you need bases.</p>	<p>Material of grid</p> <p>Grid is made from stainless steel AISI 304. Optionally we can produce grid from stainless steel AISI 316.</p>	<p>Load class of grid</p> <p>Grid is classified as K3 which means that it can withstand 300 kg of pressure.</p>	<p>Water seal height</p> <p>Model is having siphonic S base with 25mm water seal. On model can be installed both 25mm and 50mm water seal bases.</p>

Evo Ultra Thin

EVO Ultra Thin is linear shower drain from Evolution line of products. It consist of 36 different products divided in 3 groups: Line, Square and Wave represented in 6 different sizes and packed with complete set for hydroisolation and protective plastic who have dual role. "Ultra Thin" is characterized by massive designer piece grid made from stainless steel, big variety of models, set for levelling of ceramic, anti leaking system, 360 degrees rotatable base, low installation height and high flow rate.



Evo Line

EVO Line is linear shower drain from Evolution line of products. It consist 118 different products divided in 3 groups: Chrome, Glass and Invisible represented in 8 different sizes, 2 different base and packed with complete set for hydroisolation and protective styrofoam who have dual role. "Line" is characterized by designer piece grid with perfect edges, big variety of models, set for levelling of ceramic, anti leaking system, modularity, 2 different 360 degrees rotatable base, adjustable installation height and high flow rate.



Evo Unlimited

EVO Unlimited is a linear shower drain from Evolution line of products and represents a innovation in the world of shower drains. Inspiration for this model was minimalistic design & unlimited flexibility which puts ceramic in first plan. It consist multiple pieces with who you can put any requirement of your bathroom and it is packed with complete set for hydroisolation and protective plastic who have dual role. "Unlimited" is characterized by unlimited & minimalistic design, unlimited height of ceramic, unlimited flow rate, unlimited length, anti-leaking system, 360 degrees rotatable base and low installation height.







EVO

Ultra Thin

≡ EVO Ultra Thin Models

EVO Ultra Thin Line

EVO Ultra Thin Line is available in 650mm, 750mm, 850mm, 950mm, 1050mm & 1150mm sizes with design piece "Line" grid made from AISI 304 stainless steel. Grid also have K3 load class and set for levelling of ceramic. Minimum installation height is 77mm and maximum flow rate is 48 l/min which is provided by ultra low 360 degrees rotatable base with 25mm water seal height and output DN 50mm. Model can be cleaned without removing grid so it makes him "Easy 2 Clean" and consist "All you need set" so clients have in box everything needed for the installation.



EVO Ultra Thin Square

EVO Ultra Thin Square is available in 650mm, 750mm, 850mm, 950mm, 1050mm & 1150mm sizes with design piece "Square" grid made from AISI 304 stainless steel. Grid also have K3 load class and set for levelling of ceramic. Minimum installation height is 77mm and maximum flow rate is 48 l/min which is provided by ultra low 360 degrees rotatable base with 25mm water seal height and output DN 50mm. Model can be cleaned without removing grid so it makes him "Easy 2 Clean" and consist "All you need set" so client have in box everything needed for the installation.



EVO Ultra Thin Wave

EVO Ultra Thin Wave is available in 650mm, 750mm, 850mm, 950mm, 1050mm & 1150mm sizes with design piece "Wave" grid made from AISI 304 stainless steel. Grid also have K3 load class and set for levelling of ceramic. Minimum installation height is 77mm and maximum flow rate is 48 l/min which is provided by ultra low 360 degrees rotatable base with 25mm water seal height and output DN 50mm. Model can be cleaned without removing grid so it makes him "Easy 2 Clean" and consist "All you need set" so client have in box everything needed for the installation.







 **EVO**
Ultra Thin Line



EUTL 650

Product code
Chrome: 13700000
Gold: 13700010

EUTL 750

Product code
Chrome: 13700001
Gold: 13700011

EUTL 850

Product code
Chrome: 13700002
Gold: 13700012

EUTL 950

Product code
Chrome: 13700003
Gold: 13700013

EUTL 1050

Product code
Chrome: 13700004
Gold: 13700014

EUTL 1150

Product code
Chrome: 13700005
Gold: 13700015





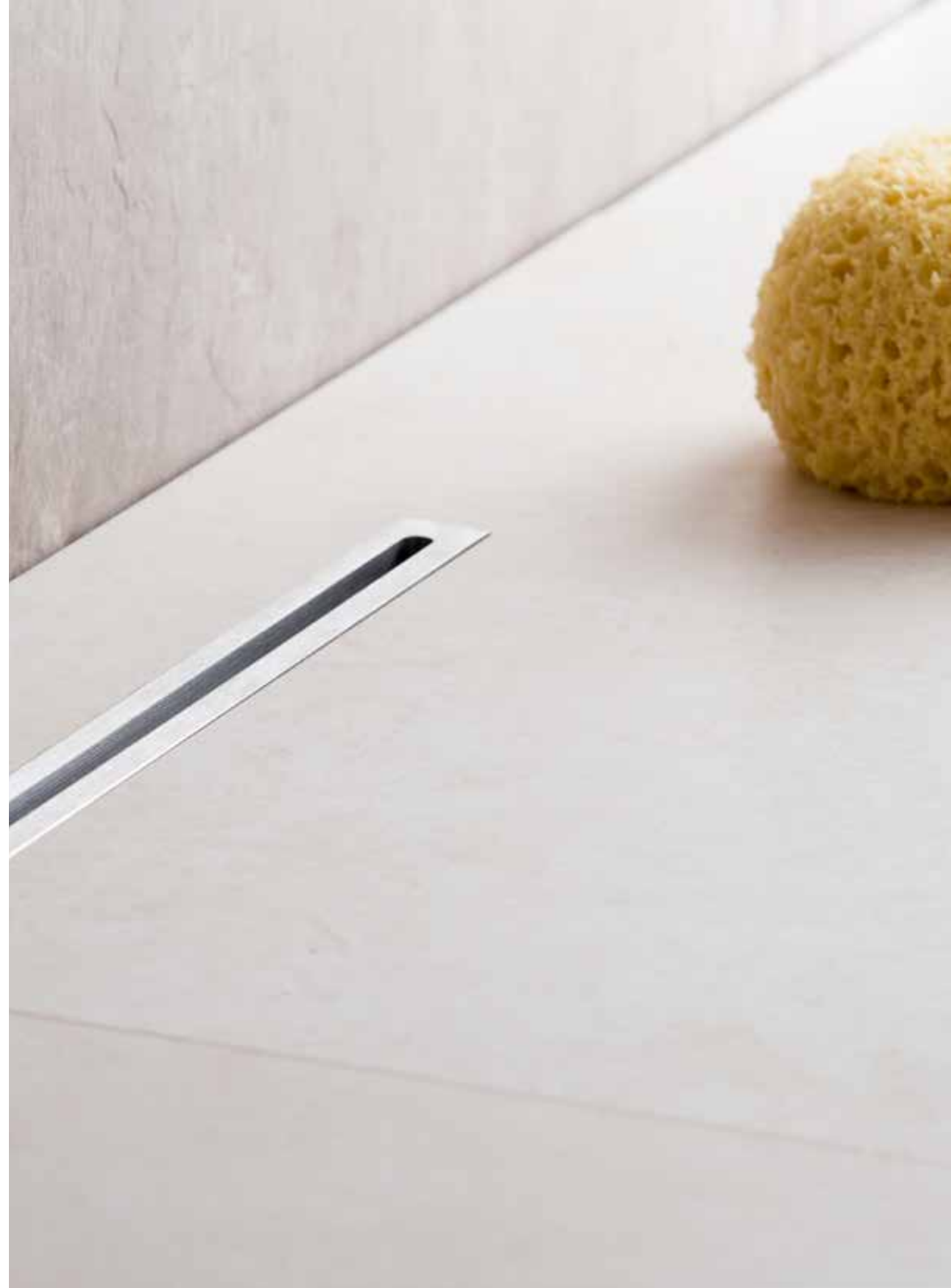



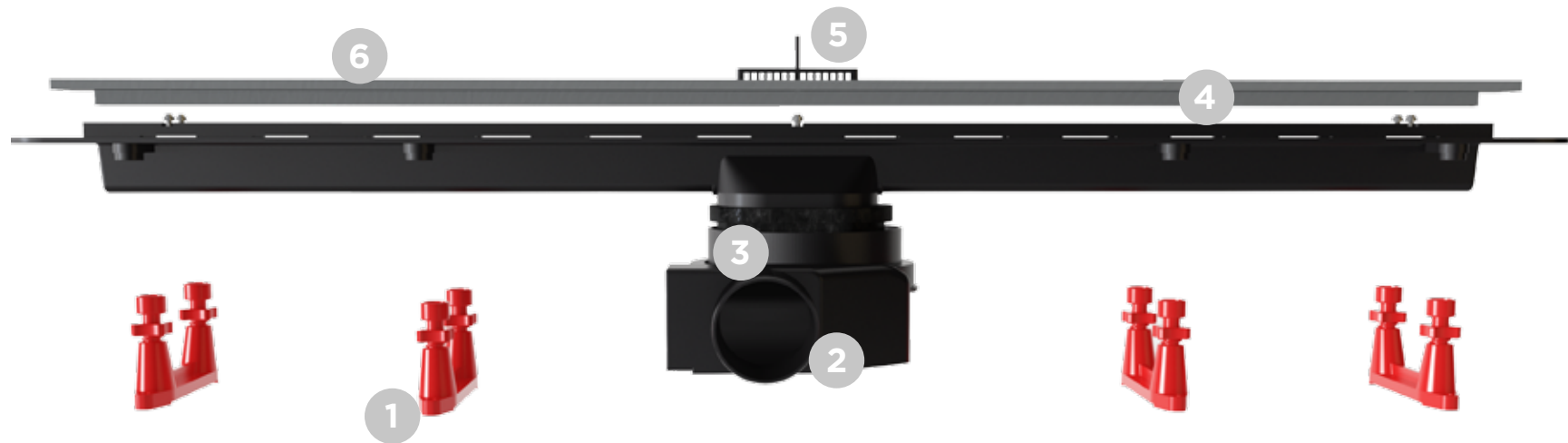

EVO Ultra Thin Line

EVO Ultra Thin Line is available in 650mm, 750mm, 850mm, 950mm, 1050mm & 1150mm sizes with design piece "Line" grid made from AISI 304 stainless steel. Grid also have K3 load class and set for levelling of ceramic. Minimum installation height is 77mm and maximum flow rate is 48 l/min which is provided by ultra low 360 degrees rotatable base with 25mm water seal height and output DN 50mm. Model can be cleaned without removing grid so it makes him "Easy 2 Clean" and consist "All you need set" so clients have in box everything needed for the installation. Model is available with 24 carat gold finish grid.



EVO Ultra Thin Line parts & specs



 77 mm	 $\text{Ø}50$ mm	 E2C	 K3
 48 L/min	 360°	 ALS	 25mm
 10 Years	 14mm-20mm	 AISI 304	

Variants of grid finishing:

Brushed Chrome
24k Gold plated

Legend:

1. Height adjustment legs.
2. Ultra low S Base
3. Reducer with rubber ring
4. Holder of grid
5. Grid for hair
6. Stainless steel "Line" grid



EVO Ultra Thin Line main advantages

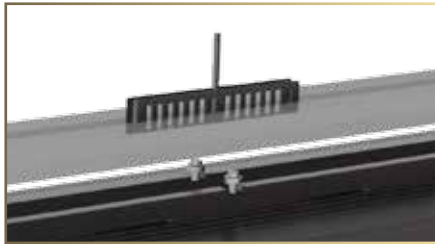

Easy To Clean

Easy cleaning of drain without removing stainless steel grid.



Anti Leaking System

Thanks to new design of holder of grid, all condensed and leaked water under the tile finds its way back to the drain. In complete with self-adhesive butyl tape which comes with the product represents the Anti Leak System.

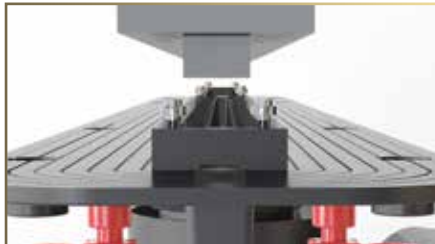

Leveling of grid

Model has a system for grid leveling so the client can have flexibility in choosing the surface in the bathroom. Adjusting is performed by tightening and loosening of leveling screws in the grid carrier. The grid can be leveled from 14mm up to 20mm of distance between the holder of the grid and the top of the grid.



Adjustment of drain height and base position

Universal solution for adjustment of installation height of the drain and possibility of rotation of the base for 360 degrees.



EVO Ultra Thin Line Technical

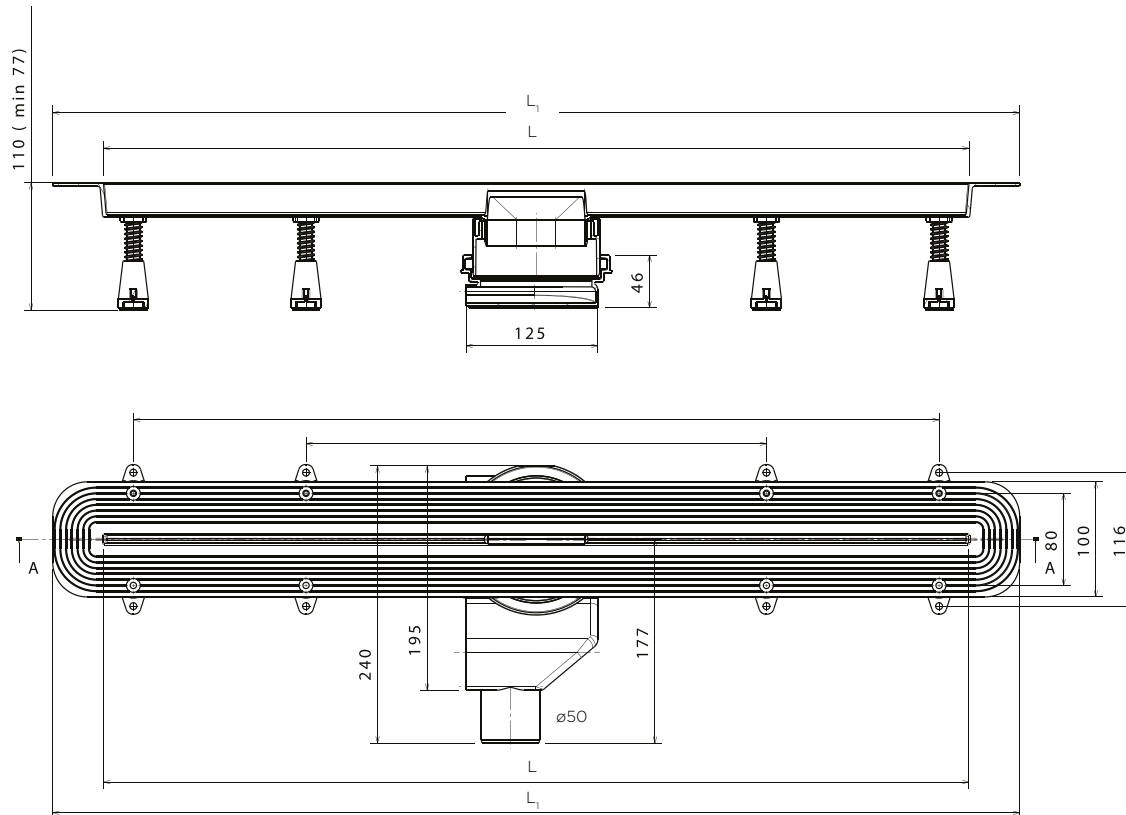

Thanks to universal solution for adjustment height of drain (DN 110mm cuttable reducer) EVO ULTRA THIN shower drain have possibility of installation in both renovation and new building bathroom projects. Minimal installation height is 77mm and maximum is 110mm which fulfills all requests of modern buildings. Height adjustment legs enables extra security during installation and use.

EVO ULTRA THIN shower drain is manufactured in different sizes. In dependence of your needs we offer following sizes: 650mm, 750mm, 850mm, 950mm, 1050mm and 1150mm.

Size	EUTL 650	EUTL 750	EUTL 850	EUTL 950	EUTL 1050	EUTL 1150
L	650	750	850	950	1050	1150
L ₁	748	848	948	1048	1148	1248



 **EVO**
Ultra thin Square



EUTS 650

Product code
Chrome: 13700030
Gold: 13700040

EUTS 750

Product code
Chrome: 13700031
Gold: 13700041

EUTS 850

Product code
Chrome: 13700032
Gold: 13700042

EUTS 950

Product code
Chrome: 13700033
Gold: 13700043

EUTS 1050

Product code
Chrome: 13700034
Gold: 13700044

EUTS 1150

Product code
Chrome: 13700035
Gold: 13700045





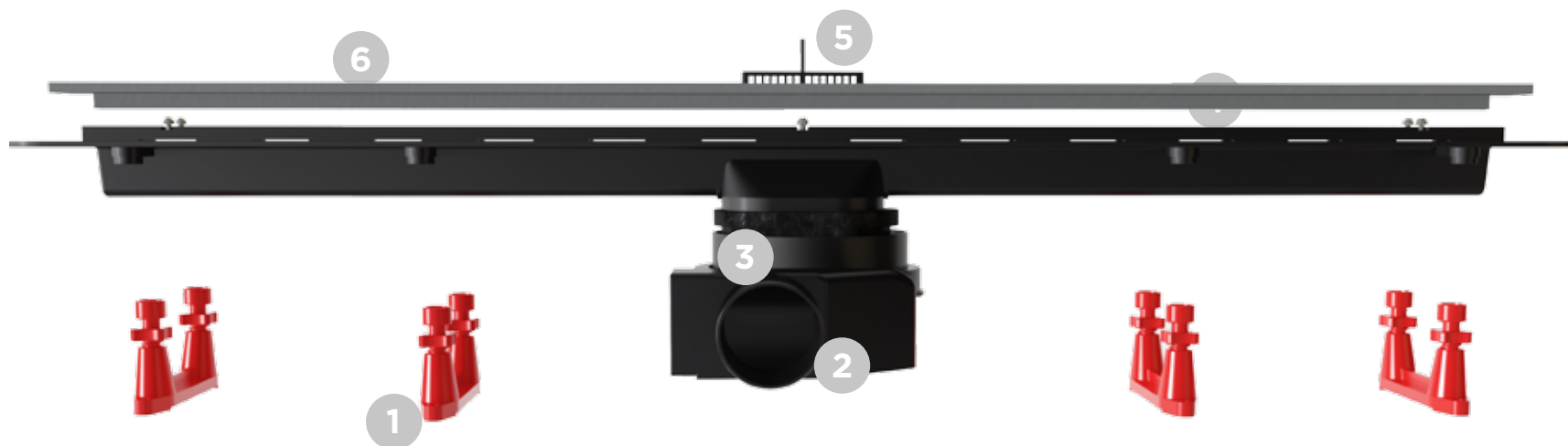

EVO Ultra Thin Square

EVO Ultra Thin Square is available in 650mm, 750mm, 850mm, 950mm, 1050mm & 1150mm sizes with design piece "Square" grid made from AISI 304 stainless steel. Grid also have K3 load class and set for levelling of ceramic. Minimum installation height is 77mm and maximum flow rate is 48 l/min which is provided by ultra low 360 degrees rotatable base with 25mm water seal height and output DN 50mm. Model can be cleaned without removing grid so it makes him "Easy 2 Clean" and consist "All you need set" so client have in box everything needed for the installation. Model is available with 24 carat gold finish grid.



EVO Ultra Thin Square parts & specs



 77 mm	 Ø50 mm	 E2C	K3
 48 L/min	 360°	 ALS	 25mm
 10 Years	 14mm-20mm	AISI 304	

Variants of grid finishing:

Brushed Chrome
24k Gold plated

Legend:

1. Height adjustment legs.
2. Ultra low S Base
3. Reducer with rubber ring
4. Holder of grid
5. Grid for hair
6. Stainless steel "Square" grid



EVO Ultra Thin Square main advantages

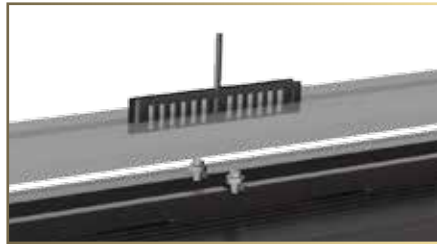

Easy To Clean

Easy cleaning of drain without removing stainless steel grid.

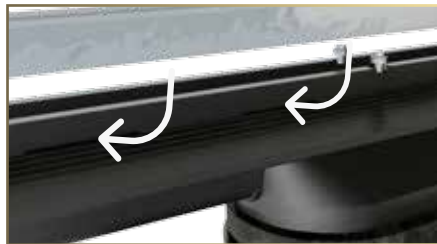

Anti Leaking System

Thanks to new design of holder of grid, all condensed and leaked water under the tile finds its way back to the drain. In complete with self-adhesive butyl tape which comes with the product represents the Anti Leak System.



Leveling of grid

Model has a system for grid leveling so the client can have flexibility in choosing the surface in the bathroom. Adjusting is performed by tightening and loosening of leveling screws in the grid carrier. The grid can be leveled from 14mm up to 20mm of distance between the holder of the grid and the top of the grid.



Adjustment of drain height and base position

Universal solution for adjustment of installation height of the drain and possibility of rotation of the base for 360 degrees.



EVO Ultra Thin Square Technical

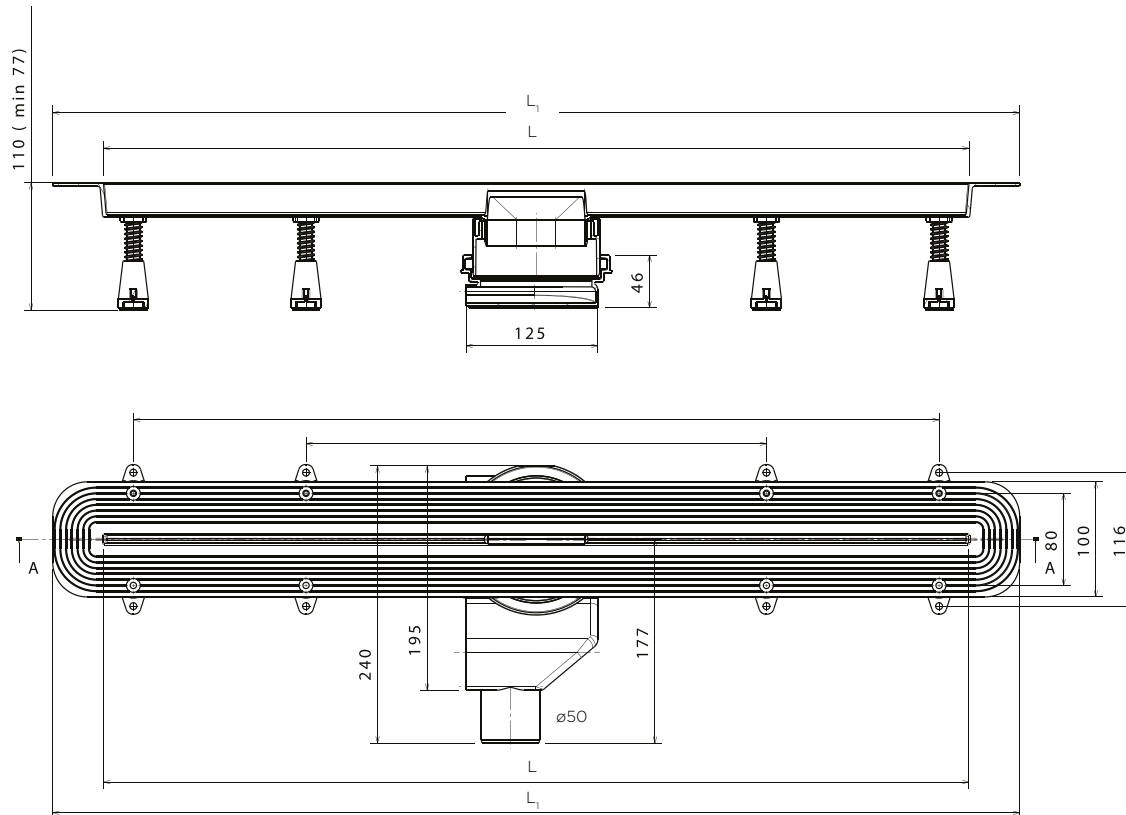

Thanks to universal solution for adjustment height of drain (DN 110mm cuttable reducer) EVO ULTRA THIN shower drain have possibility of installation in both renovation and new building bathroom projects. Minimal installation height is 77mm and maximum is 110mm which fulfills all requests of modern buildings. Height adjustment legs enables extra security during installation and use.

EVO ULTRA THIN shower drain is manufactured in different sizes. In dependence of your needs we offer following sizes: 650mm, 750mm, 850mm, 950mm, 1050mm and 1150mm.

Size	EUTS 650	EUTS 750	EUTS 850	EUTS 950	EUTS 1050	EUTS 1150
L	650	750	850	950	1050	1150
L ₁	748	848	948	1048	1148	1248



 **EVO**
Ultra thin Wave



EUTW 650

Product code
Chrome: 13700050
Gold: 13700060

EUTW 750

Product code
Chrome: 13700051
Gold: 13700061

EUTW 850

Product code
Chrome: 13700052
Gold: 13700062

EUTW 950

Product code
Chrome: 13700053
Gold: 13700063

EUTW 1050

Product code
Chrome: 13700054
Gold: 13700064

EUTW 1150

Product code
Chrome: 13700055
Gold: 13700065







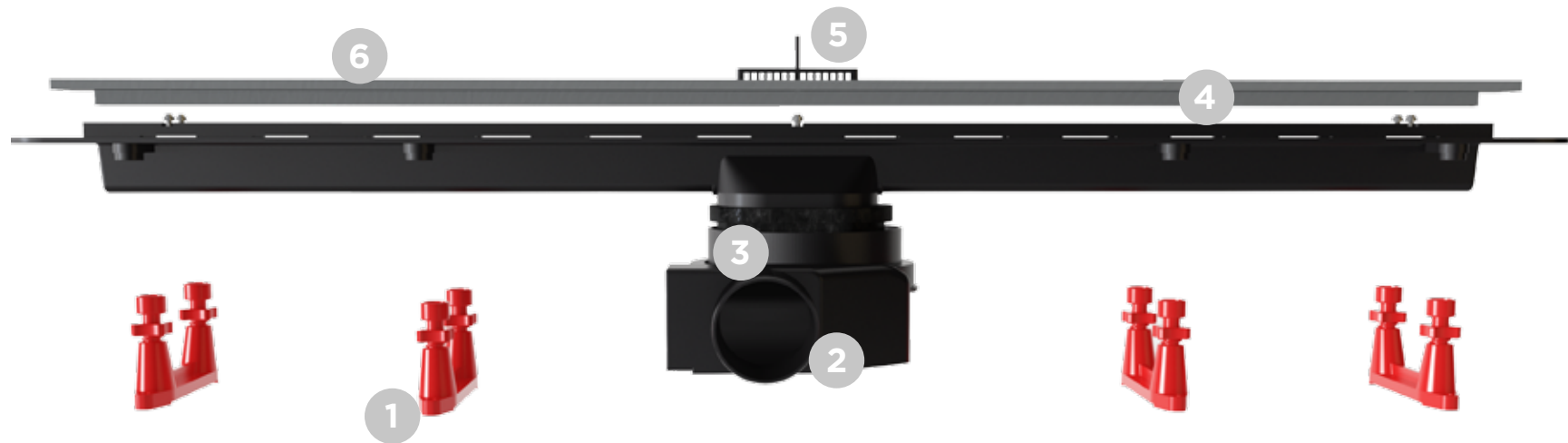

EVO Ultra Thin Wave

EVO Ultra Thin Wave is available in 650mm, 750mm, 850mm, 950mm, 1050mm & 1150mm sizes with design piece “Wave” grid made from AISI 304 stainless steel. Grid also have K3 load class and set for levelling of ceramic. Minimum installation height is 77mm and maximum flow rate is 48 l/min which is provided by ultra low 360 degrees rotatable base with 25mm water seal height and output DN 50mm. Model can be cleaned without removing grid so it makes him “Easy 2 Clean” and consist “All you need set” so client have in box everything needed for the installation. Model is available with 24 carat gold finish grid.



EVO Ultra Thin Wave parts & specs



 77 mm	 $\text{Ø}50$ mm	 E2C	K3
 48 L/min	 360°	 ALS	 25mm
 10 Years	 14mm-20mm	AISI 304	

Variants of grid finishing:

Brushed Chrome
24k Gold plated

Legend:

1. Height adjustment legs.
2. Ultra low S Base
3. Reducer with rubber ring
4. Holder of grid
5. Grid for hair
6. Stainless steel "Wave" grid



EVO Ultra Thin Wave main advantages

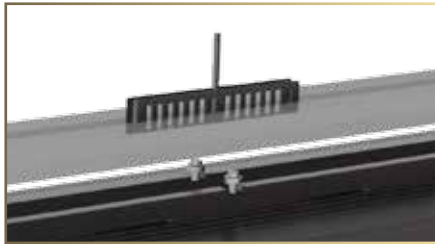

Easy To Clean

Easy cleaning of drain without removing stainless steel grid.



Anti Leaking System

Thanks to new design of holder of grid, all condensed and leaked water under the tile finds its way back to the drain. In complete with self-adhesive butyl tape which comes with the product represents the Anti Leak System.

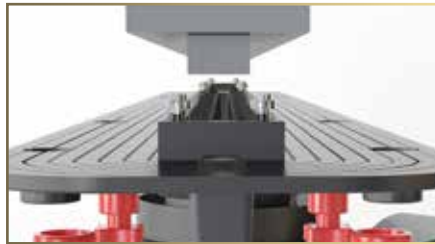

Leveling of grid

Model has a system for grid leveling so the client can have flexibility in choosing the surface in the bathroom. Adjusting is performed by tightening and loosening of leveling screws in the grid carrier. The grid can be leveled from 14mm up to 20mm of distance between the holder of the grid and the top of the grid.



Adjustment of drain height and base position

Universal solution for adjustment of installation height of the drain and possibility of rotation of the base for 360 degrees.



EVO Ultra Thin Wave Technical

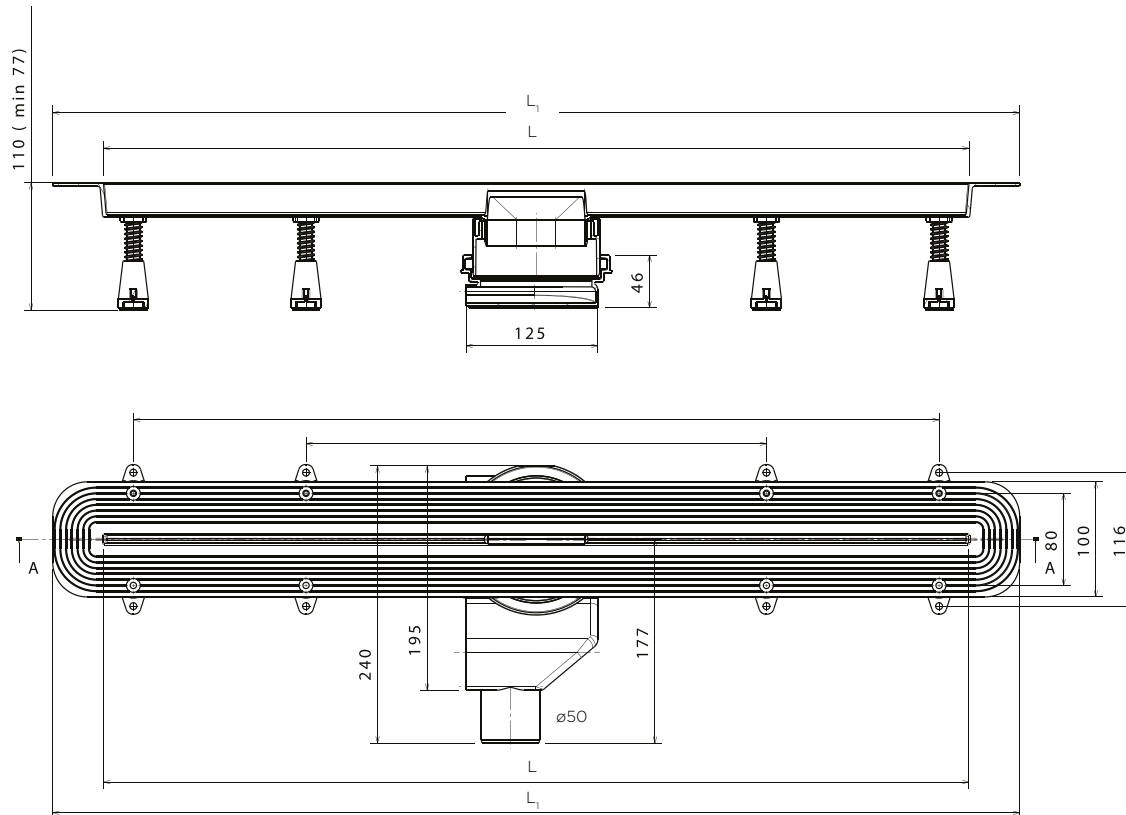

Thanks to universal solution for adjustment height of drain (DN 110mm cuttable reducer) EVO ULTRA THIN shower drain have possibility of installation in both renovation and new building bathroom projects. Minimal installation height is 77mm and maximum is 110mm which fulfills all requests of modern buildings. Height adjustment legs enables extra security during installation and use.

EVO ULTRA THIN shower drain is manufactured in different sizes. In dependence of your needs we offer following sizes: 650mm, 750mm, 850mm, 950mm, 1050mm and 1150mm.

Size	EUTW 650	EUTW 750	EUTW 850	EUTW 950	EUTW 1050	EUTW 1150
L	650	750	850	950	1050	1150
L ₁	748	848	948	1048	1148	1248

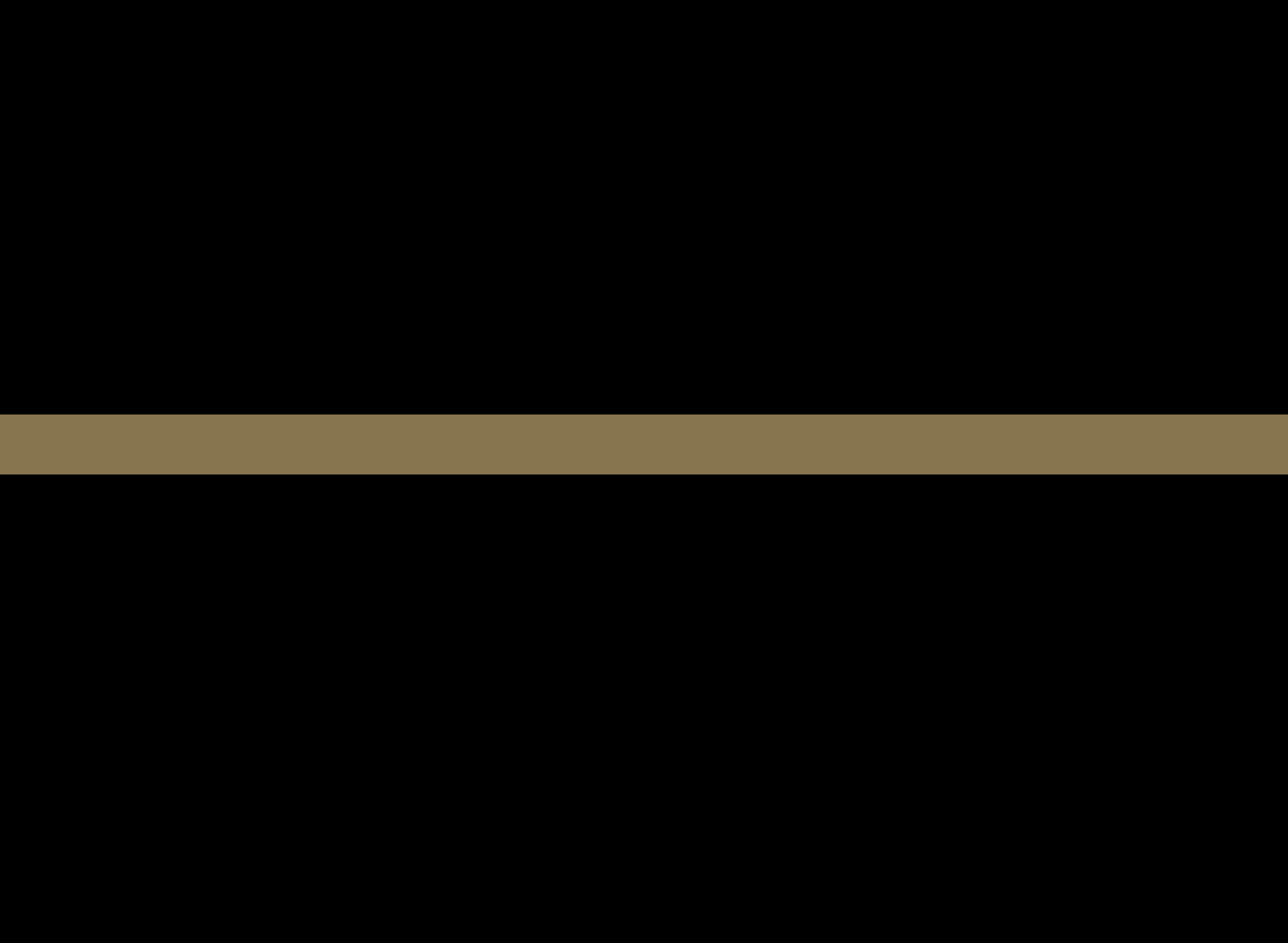



EVO
Line

≡ EVO Line Models

EVO Line Glass White

EVO Line Glass White is available in 300mm, 450mm, 550mm, 650mm, 750mm, 850mm, 950mm, 1050mm, 1150mm sizes with chamfered edge grid made from White tempered glass. In this model you can chose 2 different

base, depending are you gonna use it in renovation projects or in new building. Product consist "All you need set" so client have in box everything needed for the installation.

EVO Line Glass Black

EVO Line Glass Black is available in 300mm, 450mm, 550mm, 650mm, 750mm, 850mm, 950mm, 1050mm, 1150mm sizes with chamfered edge grid made from Black tempered glass. In this model you can chose 2 different base, depending are you gonna use it in renovation projects or in new building. Product consist "All you need set" so client have in box everything needed for the installation.

EVO Line Invisible

EVO LINE Invisible is available in 300mm, 450mm, 550mm, 650mm, 750mm, 850mm, 950mm, 1050mm, 1150mm sizes with stainless steel holder of ceramic who provides invisibility of shower drain, unlimited leveling of ceramic and has K3 load class. In this model you can chose 2 different base, depending are you gonna use it in renovation projects or in new building. Model consist "All you need set" so client have in box everything needed for the installation.

EVO Line Chrome

EVO LINE Chrome is available in 300mm, 450mm, 550mm, 650mm, 750mm, 850mm, 950mm, 1050mm, 1150mm sizes with perfect final touch 2 in 1 grid made from AISI 304 stainless steel and K3 load class. In this model you can chose 2 different base, depending are you gonna use it in renovation projects or in new building. Model consist "All you need set" so client have in box everything needed for the installation and it is available also with 24k gold finish grid.







 **EVO**
Line Glass White



ELGW 300

Product code
Glass: 13700070

ELGW 450

Product code
Glass: 13700071

ELGW 550

Product code
Glass: 13700072

ELGW 650

Product code
Glass: 13700073

ELGW 750

Product code
Glass: 13700074

ELGW 850

Product code
Glass: 13700075

ELGW 950

Product code
Glass: 13700076

ELGW 1050

Product code
Glass: 13700077

ELGW 1150

Product code
Glass: 13700078

EVO Line Glass White

EVO Line Glass White is available in 300mm, 450mm, 550mm, 650mm, 750mm, 850mm, 950mm, 1050mm 1150mm sizes with chamfered edge grid made from White tempered glass. In this model you can chose 2 different base, depending are you gonna use it in renovation projects or in new building. Model with Ultra Low S base have 62mm installation height, 25mm water seal and DN 50 mm horizontal outlet and it is used mainly for renovation projects. Model with Standard base have 125mm installation height, 50mm water seal and DN 50 mm horizontal outlet and it is in accordance with EN 1253 and recommended to use in new building projects. Product consist "All you need set" so client have in box everything needed for the installation.



EVO Line Glass White parts & specs



RENOVATION 62mm 25mm	NEW BUILDING 125mm 50mm	ALS 	K3
48 L/min	360°	16mm-30mm	Ø50 mm
10 Years			

Legend:

1. Height adjustment legs
2. Ultra low S Base
3. Reducer with rubber ring
4. Holder of grid
5. Grid for hair
6. Bridges for leveling of ceramic
7. White glass grid



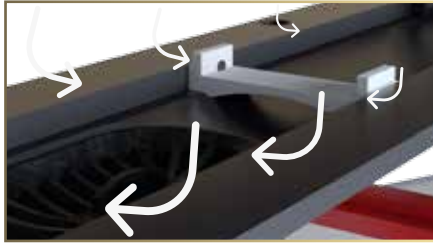

Anti Leaking System

Thanks to new design of holder of grid, all condensed and leaked water under the tile finds its way back to the drain. In complete with self-adhesive butyl tape which comes with the product represents the Anti Leak System.



Leveling of ceramic

Model has a system for grid leveling so the client can have flexibility in choosing the surface in the bathroom. Adjusting is performed by tightening and loosening of leveling screws in the grid carrier. The grid can be leveled from 16mm up to 30mm of distance between the holder of the grid and the top of the grid.

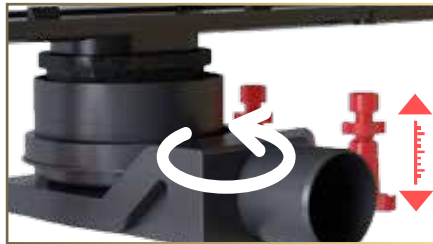

Adjustment of drain height and base position

Universal solution for adjustment of installation height of the drain and possibility of rotation of the base for 360 degrees.



5 cm water seal set

As all of the Evolution shower drains are modular, the client can, by changing the Ultra low S base with this 2-part set, adjust all of our EVOLUTION LINE models to have 5 cm of water seal and in that way to be in accordance with EN 1253. Benefits of this model are: 15° rotatable adapter on the base, the adapter on the base is made from ABS so it can be connected both with push fit and solvent cement piping systems, the product is in accordance with EN 1253 and this makes it perfect for new building projects, the siphon can be cleaned very easily with simple pulling out of the cover of the siphon.



EVO Line Glass White Technical

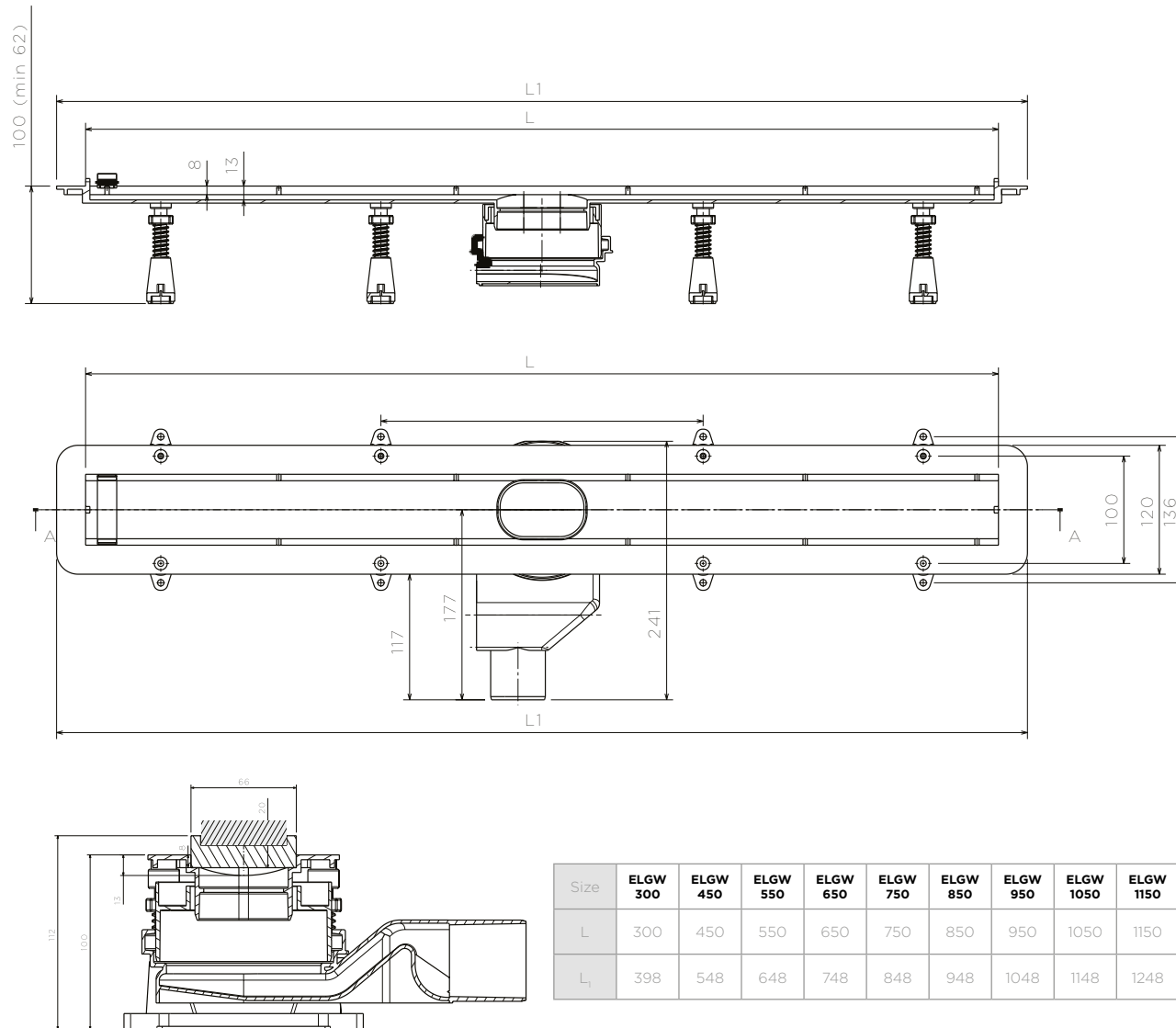

Thanks to new design of holder of grid, all condensed and leaked water under the tile finds it way back to the drain. In complete with self - adhesive butyl tape comes with product and makes Anti Leaking System.

Uniquesolutionforlevelingofgridofdrain in dependence of thickness of chosen ceramic by choosing different bridges for leveling. From 16mm up to 30mm.

Universal solution for adjustment of installation height of drain and possibility of rotation of base for 360 degrees. Thanks to universal solution for adjustment height of drain (DN 110mm cuttable reducer) EVO LINE shower drain have possibility of installation in both renovation and new building bathroom projects. Minimum installation height is 77mm and maximum is 110mm which fulfills all requests of modern buildings. Heigh adjustment legs enables extra security during instalation and use.

EVO LINE shower drain is manufactured in different sizes and is designed to satisfy most demanding customers regarding of their length. In dependence of your needs we offer following sizes: 650mm, 750mm, 850mm, 950mm and 1050mm.



 EVO
Line Glass Black



ELGB 300

Product code
13700090

ELGB 450

Product code
13700091

ELGB 550

Product code
13700092

ELGB 650

Product code
13700093

ELGB 750

Product code
13700094

ELGB 850

Product code
13700095

ELGB 950

Product code
13700096

ELGB 1050

Product code
13700097

ELGB 1150

Product code
13700098

EVO Line Glass Black

EVO LINE Invisible is available in 300mm, 450mm, 550mm, 650mm, 750mm, 850mm, 950mm, 1050mm 1150mm sizes with stainless steel holder of ceramic who provides invisibility of shower drain, unlimited leveling of ceramic and has K3 load class. In this model you can chose 2 different base, depending are you gonna use it in rennovation projects or in new building. Model with Ultra Low S base have 62mm installation heigh, 25mm water seal and DN 50 mm horizontal outlet and it is used mainly for rennovation projects. Model with Standard base have 125mm installation height, 50mm water seal and DN 50 mm horizontal outlet and it is in accordance with EN 1253 and recomended to use in new building projects. Model consist "All you need set" so client have in box everything needed for the installation.



EVO Line Glass Black parts & specs



RENOVATION 62mm 25mm	NEW BUILDING 125mm 50mm	ALS 	K3
48 L/min	360°	16mm-30mm	Ø50 mm
10 Years			

LEGEND:

1. Height adjustment legs
2. Ultra low S Base
3. Reducer with rubber ring
4. Holder of grid
5. Grid for hair
6. Bridges for leveling of ceramic
7. Black Glass grid



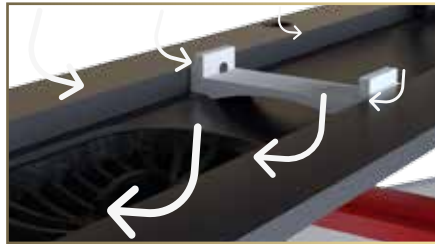

Anti Leaking System

Thanks to new design of holder of grid, all condensed and leaked water under the tile finds its way back to the drain. In complete with self-adhesive butyl tape which comes with the product represents the Anti Leak System.



Leveling of ceramic

Model has a system for grid leveling so the client can have flexibility in choosing the surface in the bathroom. Adjusting is performed by tightening and loosening of leveling screws in the grid carrier. The grid can be leveled from 16mm up to 30mm of distance between the holder of the grid and the top of the grid.



Adjustment of drain height and base position

Universal solution for adjustment of installation height of the drain and possibility of rotation of the base for 360 degrees.



5 cm water seal set

As all of the Evolution shower drains are modular, the client can, by changing the Ultra low S base with this 2-part set, adjust all of our EVOLUTION LINE models to have a 5 cm water seal and in that way to be in accordance with EN 1253. Benefits of this model are: 15° rotatable adapter on the base, the adapter on the base is made from ABS so it can be connected both with push fit and solvent cement piping systems, the product is in accordance with EN 1253 and this makes it perfect for new building projects, the siphon can be cleaned very easily with simple pulling out of the cover of the siphon.



EVO Line Glass Black Technical

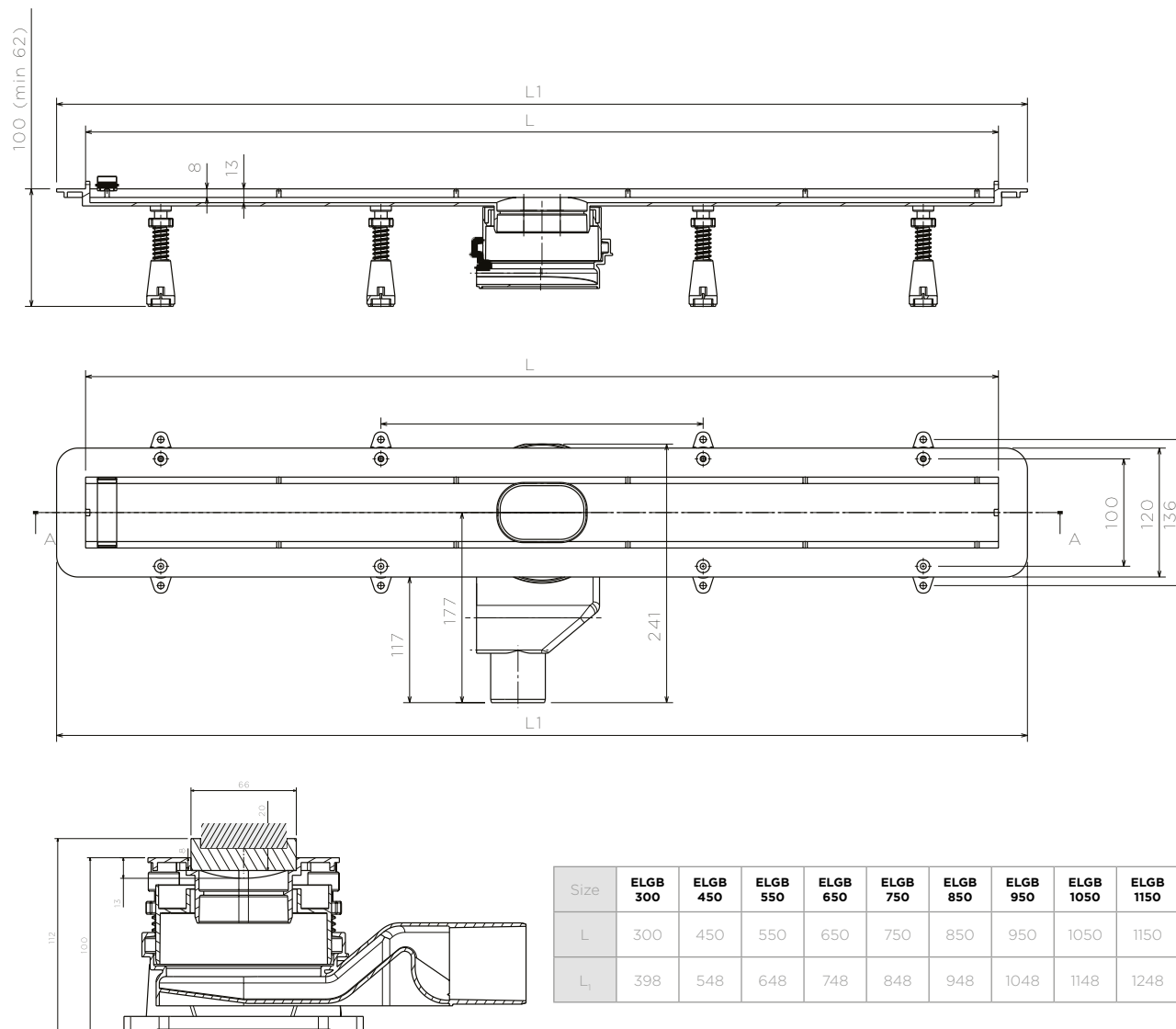

Size	ELGB 300	ELGB 450	ELGB 550	ELGB 650	ELGB 750	ELGB 850	ELGB 950	ELGB 1050	ELGB 1150
L	300	450	550	650	750	850	950	1050	1150
L ₁	398	548	648	748	848	948	1048	1148	1248

Thanks to new design of holder of grid, all condensed and leaked water under the tile finds it way back to the drain. In complete with self - adhesive butyl tape comes with product and makes Anti Leaking System.

Uniquesolutionforlevelingofgridofdrain in dependence of thickness of chosen ceramic by choosing different bridges for leveling. From 16mm up to 30mm.

Universal solution for adjustment of installation height of drain and possibility of rotation of base for 360 degrees. Thanks to universal solution for adjustment height of drain (DN 110mm cuttable reducer) EVO LINE shower drain have possibility of installation in both renovation and new building bathroom projects. Minimum installation height is 77mm and maximum is 110mm which fulfills all requests of modern buildings. Heigh adjustment legs enables extra security during instalation and use.

EVO LINE shower drain is manufactured in different sizes and is designed to satisfy most demanding customers regarding of their length. In dependence of your needs we offer following sizes: 650mm, 750mm, 850mm, 950mm and 1050mm.



EVO

Line Invisible



ELIN 300

Product code:
13700120

ELIN 450

Product code:
13700121

ELIN 550

Product code:
13700122

ELIN 650

Product code:
13700123

ELIN 750

Product code:
13700124

ELIN 850

Product code:
13700125

ELIN 950

Product code:
13700126

ELIN 1050

Product code:
13700127

ELIN 1150

Product code:
13700128

EVO Line Invisible

EVO LINE Invisible is available in 300mm, 450mm, 550mm, 650mm, 750mm, 850mm, 950mm, 1050mm 1150mm sizes with stainless steel holder of ceramic who provides invisibility of shower drain, unlimited leveling of ceramic and has K3 load class. In this model you can chose 2 different base, depending are you gonna use it in rennovation projects or in new building. Model with Ultra Low S base have 62mm installation heigh, 25mm water seal and DN 50 mm horizontal outlet and it is used mainly for rennovation projects. Model with Standard base have 125mm installation height, 50mm water seal and DN 50 mm horizontal outlet and it is in accordance with EN 1253 and recomended to use in new building projects. Model consist "All you need set" so client have in box everything needed for the installation.



EVO Line Invisible parts & specs

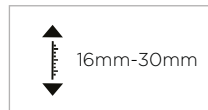
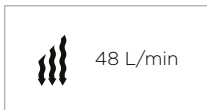

LEGEND:

1. Height adjustment legs
2. Ultra low S Base
3. Reducer with rubber ring
4. Holder of grid
5. Grid for hair
6. Bridges for leveling of ceramic
7. Ceramic



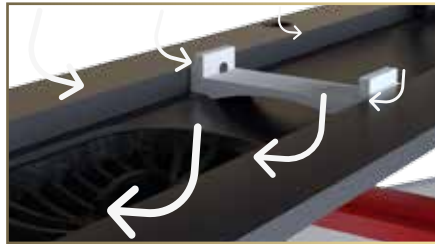

Anti Leaking System

Thanks to new design of holder of grid, all condensed and leaked water under the tile finds its way back to the drain. In complete with self - adhesive butyl tape who comes with product represent Anti Leak System.



Leveling of ceramic

Model have system for grid leveling so client can have flexibility in choosing surface in bathroom. Adjusting is performed by tightening and loosening of leveling screws in grid carrier. Grid can be leveled from 16mm up to 30mm of distance between holder of grid and top of the grid.



Adjustment of drain height and base position

Universal solution for adjustment of installation height of drain and possibility of rotation of base for 360 degrees.



5 cm water seal set

As all of the Evolution shower drains are modular, client can with changing Ultra low S base with this 2 parts adjust all of our EVOLUTION LINE models to have 5 cm of water seal and in that way to be in accordance with EN 1253. Benefits of this model are: 15° rotatable adapter on base, Adapter on base is made from ABS so it can be connected both with push fit and solvent cement piping systems, product is in accordance with EN 1253 and this makes it perfect for new buildings projects, siphon can be cleaned very easy with simple pulling out of the cover of siphon.



EVO Line Invisible Technical

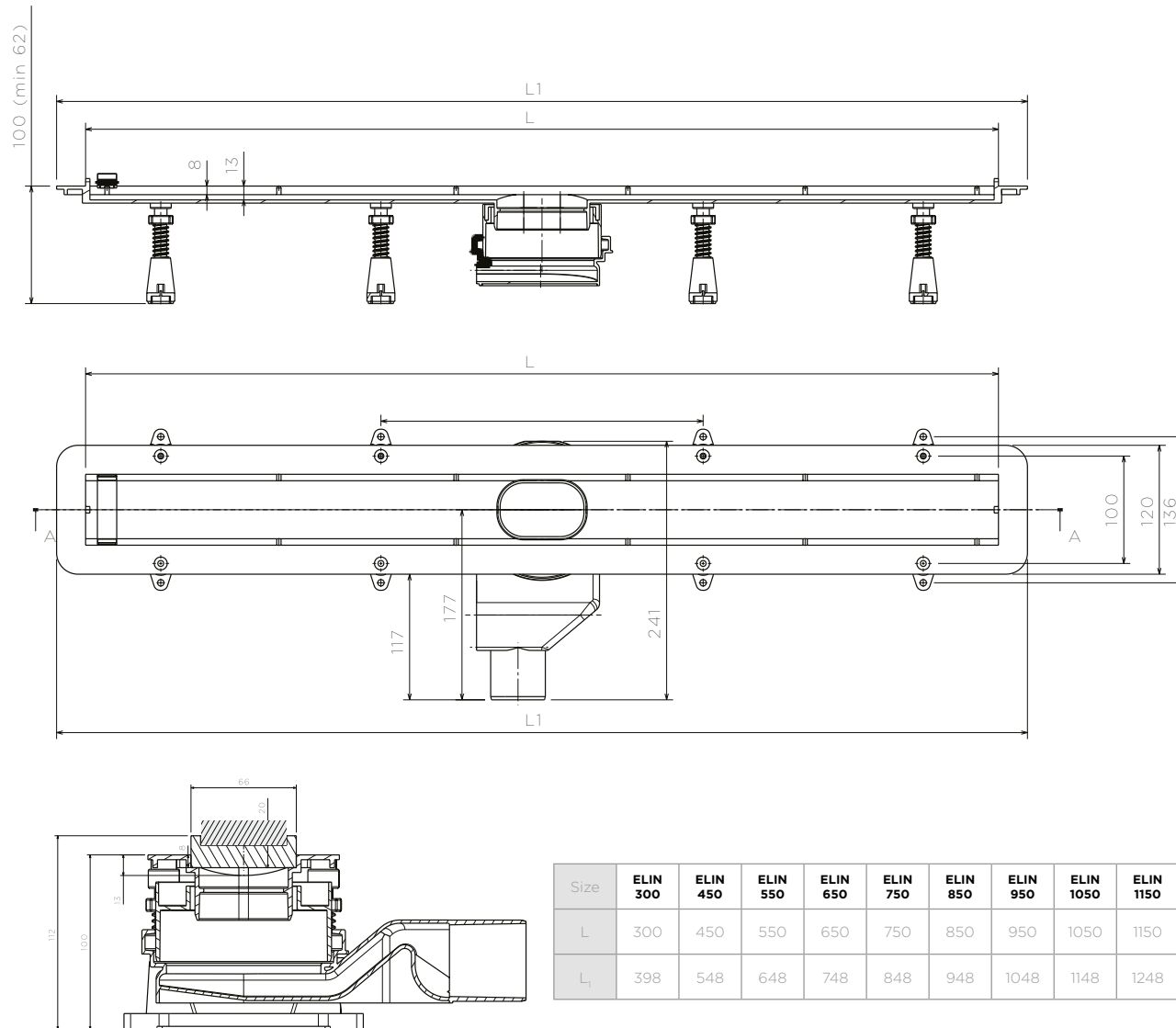

Thanks to new design of holder of grid, all condensed and leaked water under the tile finds it way back to the drain. In complete with self - adhesive butyl tape comes with product and makes Anti Leaking System.

Uniquesolutionforlevelingofgridofdrain in dependence of thickness of chosen ceramic by choosing different bridges for leveling. From 16mm up to 30mm.

Universal solution for adjustment of installation height of drain and possibility of rotation of base for 360 degrees. Thanks to universal solution for adjustment height of drain (DN 110mm cuttable reducer) EVO LINE shower drain have possibility of installation in both renovation and new building bathroom projects. Minimum installation height is 77mm and maximum is 110mm which fulfills all requests of modern buildings. Heigh adjustment legs enables extra security during instalation and use.

EVO LINE shower drain is manufactured in different sizes and is designed to satisfy most demanding customers regarding of their length. In dependence of your needs we offer following sizes: 650mm, 750mm, 850mm, 950mm and 1050mm.



 **EVO**
Line Chrome

ELCH 300

Product code:
Chrome: 13700140
Gold: 13700110

ELCH 450

Product code:
Chrome: 13700141
Gold: 13700111

ELCH 550

Product code:
Chrome: 13700142
Gold: 13700112

ELCH 650

Product code:
Chrome: 13700143
Gold: 13700113

ELCH 750

Product code:
Chrome: 13700144
Gold: 13700114

ELCH 850

Product code:
Chrome: 13700145
Gold: 13700115

ELCH 950

Product code:
Chrome: 13700146
Gold: 13700116

ELCH 1050

Product code:
Chrome: 13700147
Gold: 13700117

ELCH 1150

Product code:
Chrome: 13700148
Gold: 13700118

EVO Line Chrome

EVO LINE Chrome is available in 300mm, 450mm, 550mm, 650mm, 750mm, 850mm, 950mm, 1050mm 1150mm sizes with perfect final touch 2 in 1 grid made from AISI 304 stainless steel and K3 load class. In this model you can chose 2 different base, depending are you gonna use it in renovation projects or in new building. Model with Ultra Low S base have 62mm installation heigh, 25mm water seal and DN 50 mm horizontal outlet and it is used mainly for renovation projects. Model with Standard base have 125mm installation height, 50mm water seal and DN 50 mm horizontal outlet and it is in accordance with EN 1253 and recomended to use in new building projects. Model consist "All you need set" so client have in box everything needed for the installation and it is available also with 24k gold finish grid.



EVO Line Chrome parts & specs



RENOVATION

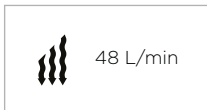
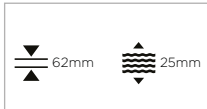

NEW BUILDING

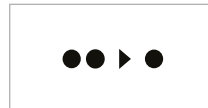
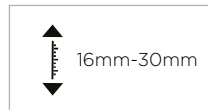
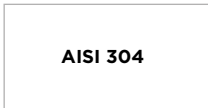
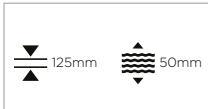

Variants of grid finishing:

Brushed Chrome
24k Gold plated

LEGEND:

1. Height adjustment legs
2. Ultra low S Base
3. Reducer with rubber ring
4. Holder of grid
5. Grid for hair
6. Bridges for leveling of ceramic
7. Chrome



EVO Line Chrome main advantages

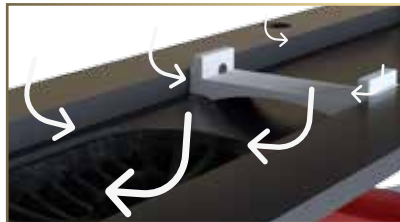

Anti Leaking System

Thanks to new design of holder of grid, all condensed and leaked water under the tile finds its way back to the drain. In complete with self-adhesive butyl tape which comes with the product represents the Anti Leak System.



Leveling of ceramic

The model has a system for grid leveling so the client can have flexibility in choosing the surface in the bathroom. Adjusting is performed by tightening and loosening of leveling screws in the grid carrier. The grid can be leveled from 16mm up to 30mm of distance between the holder of the grid and the top of the grid.



Adjustment of drain height and base position

Universal solution for adjustment of installation height of the drain and possibility of rotation of the base for 360 degrees.

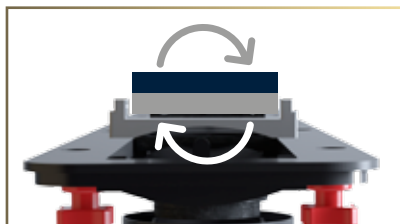

2 in 1 System

The grid of the drain can be turned and used both for stainless steel and ceramic finishes.



5 cm water seal set

As all of the Evolution shower drains are modular, the client can, by changing the Ultra low S base with this 2-part adapter, adjust all of our EVOLUTION LINE models to have 5 cm of water seal and in that way to be in accordance with EN 1253. Benefits of this model are: 15° rotatable adapter on the base. The adapter on the base is made from ABS so it can be connected both with push fit and solvent cement piping systems. The product is in accordance with EN 1253 and this makes it perfect for new building projects. The siphon can be cleaned very easily with simple pulling out of the cover of the siphon.



EVO Line Glass Black Techincal

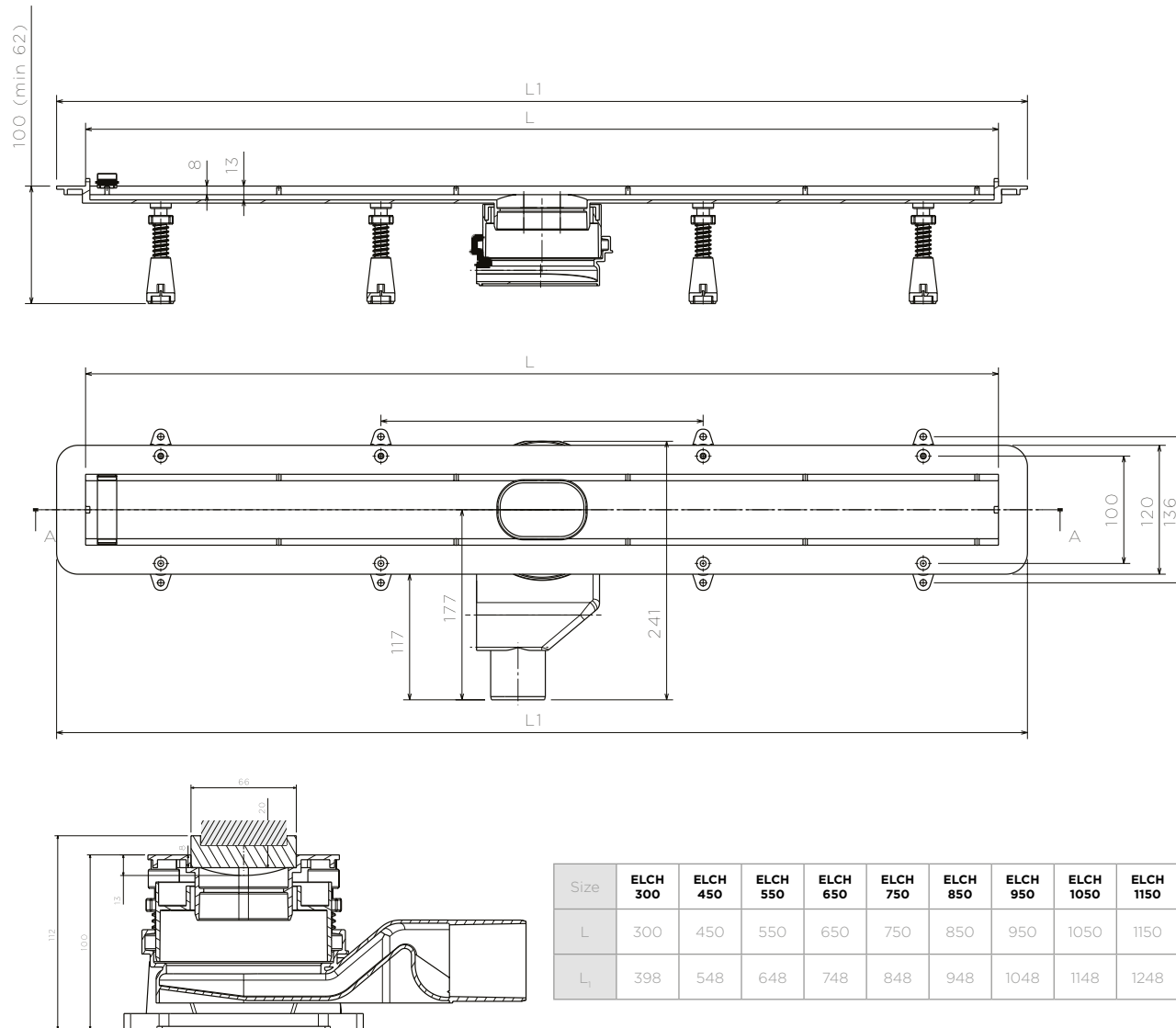

Thanks to new design of holder of grid, all condensed and leaked water under the tile finds it way back to the drain. In complete with self - adhesive butyl tape comes with product and makes Anti Leaking System.

Uniquesolutionforlevelingofgridofdrain in dependence of thickness of chosen ceramic by choosing different bridges for leveling. From 16mm up to 30mm.

Universal solution for adjustment of installation height of drain and possibility of rotation of base for 360 degrees. Thanks to universal solution for adjustment height of drain (DN 110mm cuttable reducer) EVO LINE shower drain have possibility of installation in both renovation and new building bathroom projects. Minimum installation height is 77mm and maximum is 110mm which fulfills all requests of modern buildings. Heigh adjustment legs enables extra security during instalation and use.

EVO LINE shower drain is manufactured in different sizes and is designed to satisfy most demanding customers regarding of their length. In dependence of your needs we offer following sizes: 650mm, 750mm, 850mm, 950mm and 1050mm.

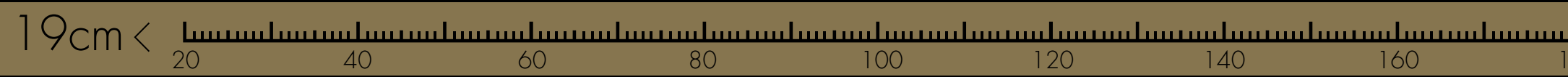

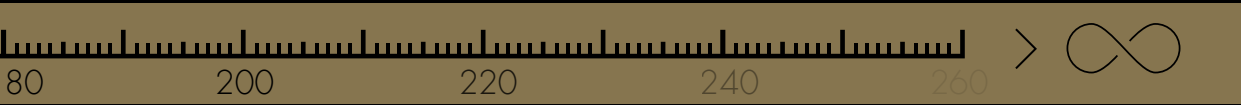

EVO
Unlimited

EUNLTD

Set
13700160

EUNLTD

Set Light
13700161

EVO Unlimited

EVO Unlimited is a linear shower drain from Evolution line of products and represents a innovation in the world of shower drains. Inspiration for this model was minimalistic design and unlimited flexibility which puts ceramic in first plan. It consist multiple pieces with who you can fulfill any requirement of your bathroom and it is packed with complete set for hydro isolation and protective plastic who have dual role. "Unlimited" is characterized by unlimited & minimalistic design, unlimited height of ceramic, unlimited flow rate, unlimited length, anti-leaking system, 360 degrees rotatable base and low installation height. Minimum installation height is 77mm and maximum flow rate per base is 48 l/min which is provided by ultra low 360 degrees rotatable base with 25mm water seal height and output DN 50mm. Model can be cleaned without removing grid so it makes him "Easy 2 Clean" and consist "All you need set" so client have in box everything needed for the installation. In dependence of your needs in EVO UNLIMITED set you can find the ideal solution for your bathroom.



EVO Unlimited parts & specs



LEGEND:

1. Height adjustment legs
2. Ultra low S Base
3. Reducer with rubber ring
4. Grid holder with vertical output
5. Grid holder without vertical output
6. Grid for hair
7. Straight connector
8. Corner connector
9. End of drain

77 mm	Ø50 mm	Unltd	360°
10 Years	Unltd	E2C	
Unltd	25mm	Unltd	

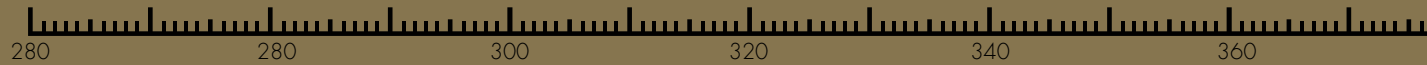

Holder of the grid with vertical output



Holder of the grid without vertical output



Corner connector



End of drain

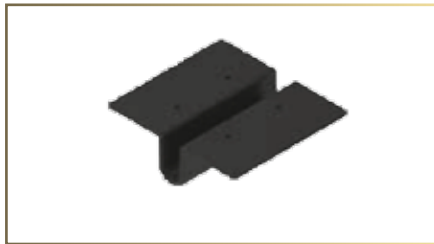

Straight connector



Rubber ring



Reducer of drain



Ultra Low S base

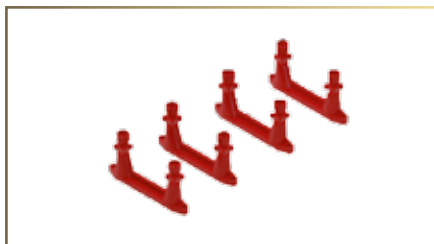

Height adjustment legs

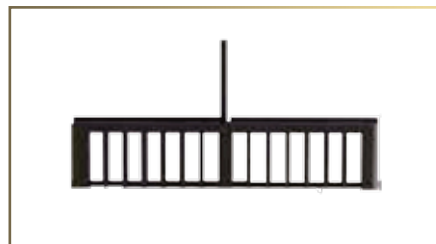

Grid for hair



Screws



Special adhesive for bonding parts of drains

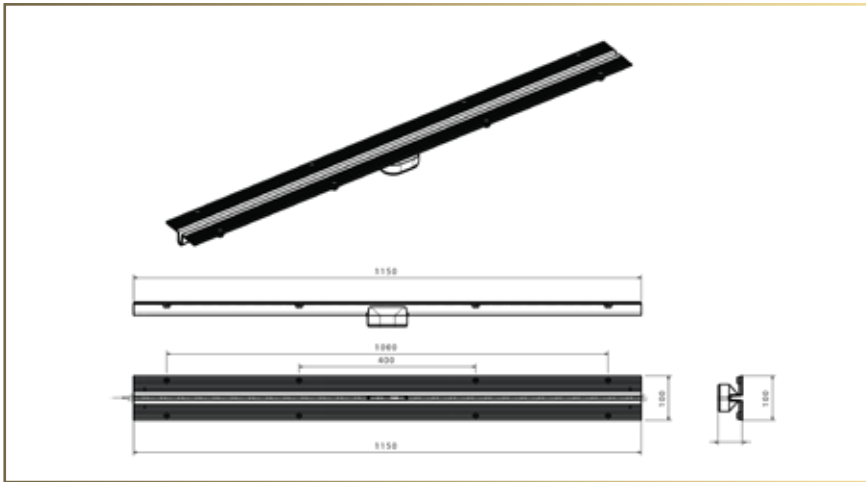

Holder of the grid with vertical output

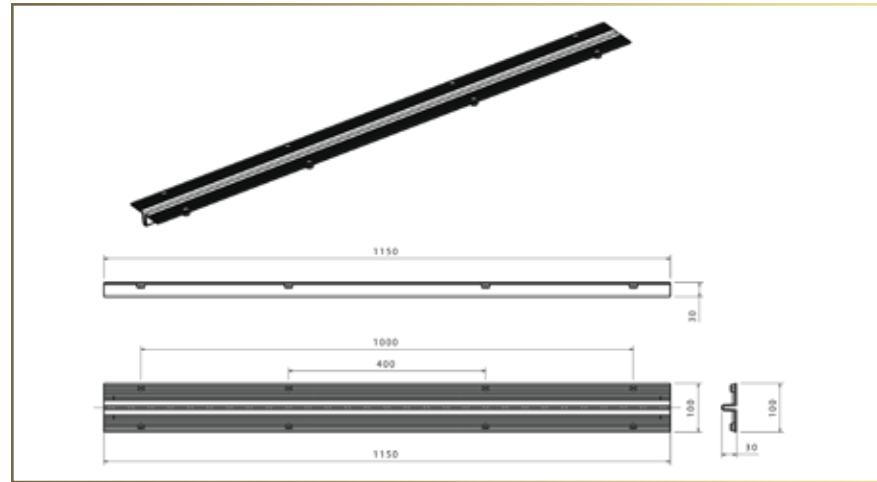

Holder of the grid without vertical output

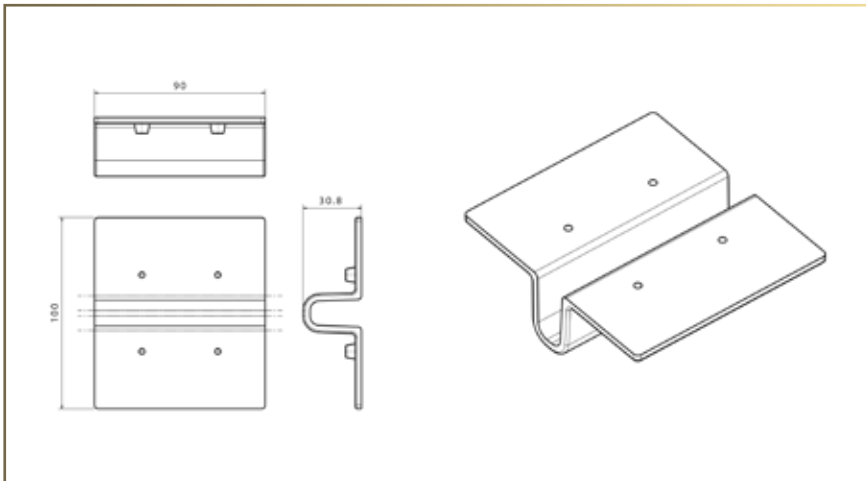

Straight connector

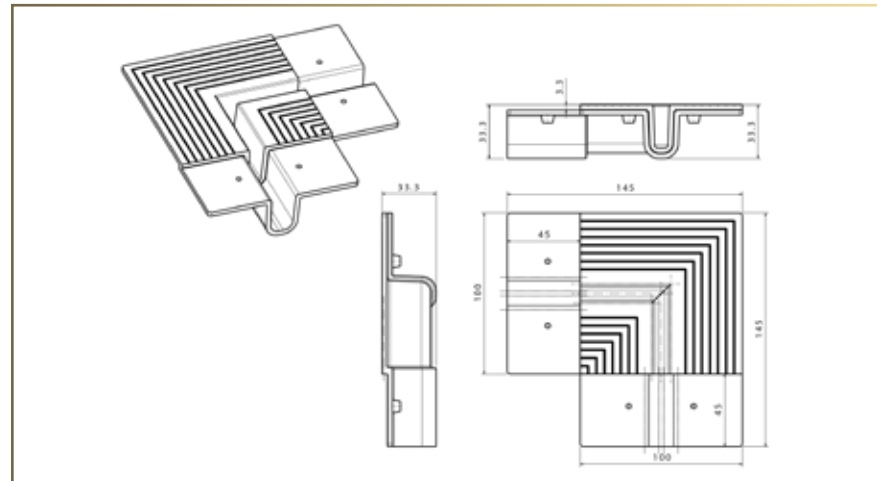

Corner connector

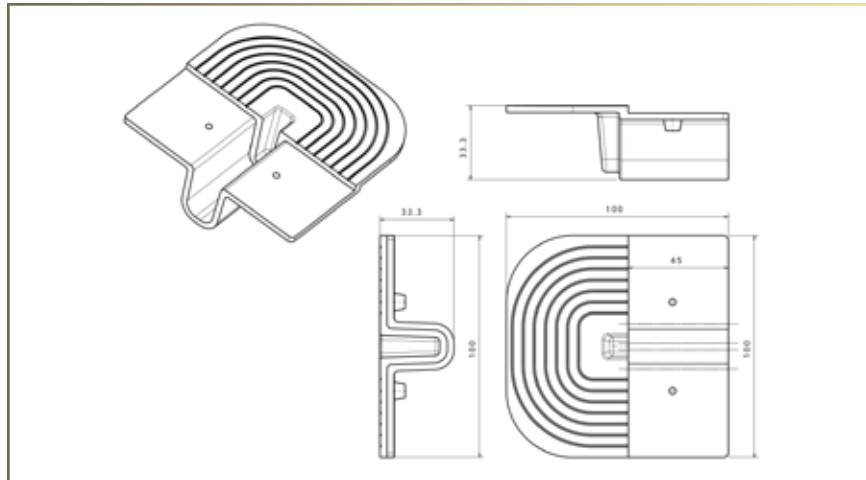

End of drain

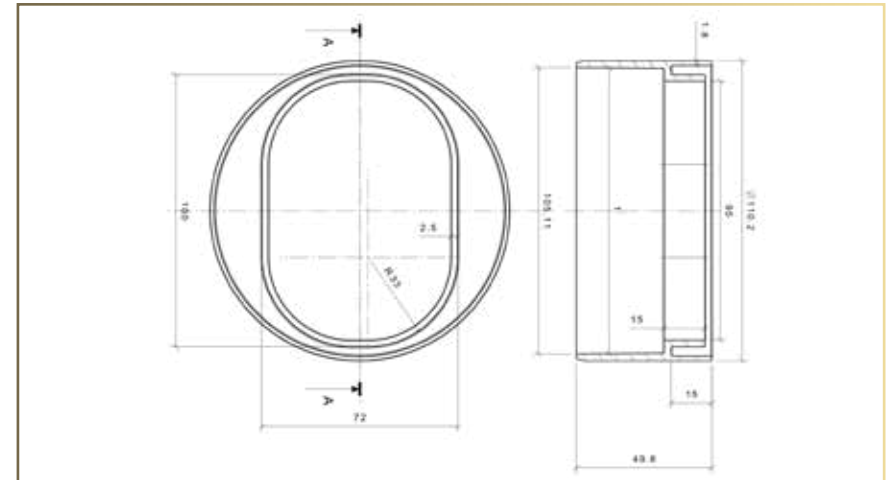

Rubber ring

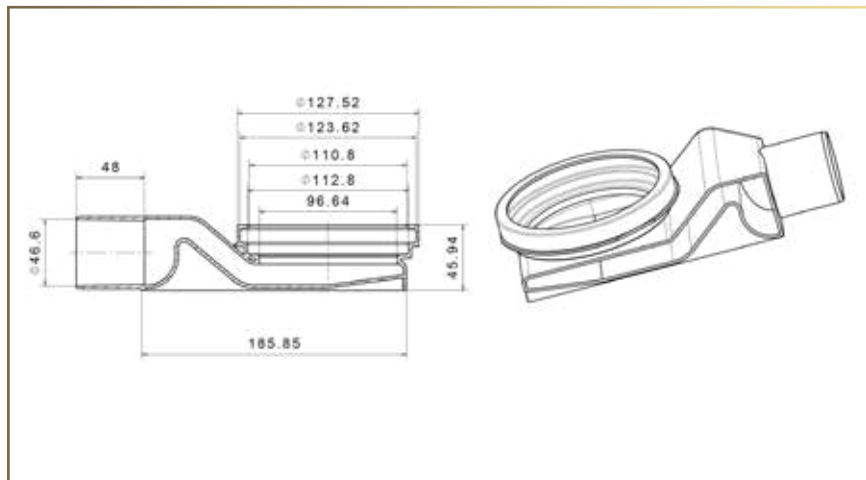

Base of drain

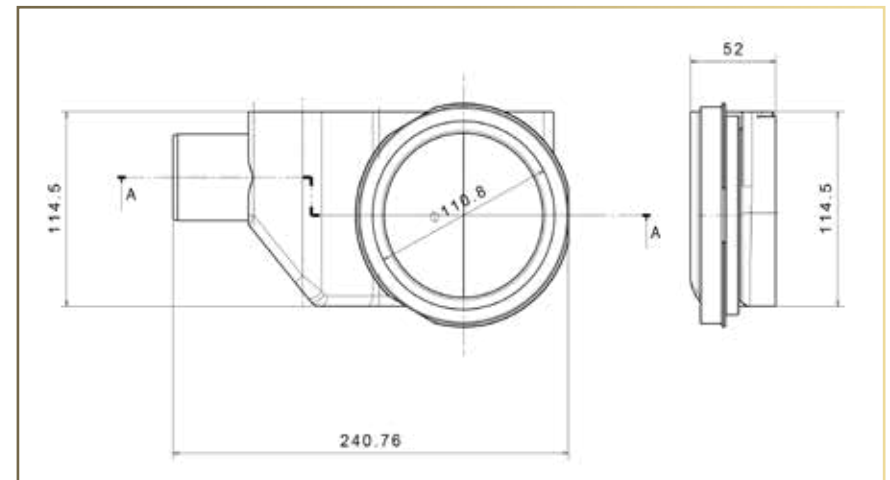

Base of drain





Easy To Clean

Easy cleaning of drain with just simple pulling out of grid for hair from interior of drain.



Anti Leaking System

Thanks to new design of holder of grid, all condensed and leaked water under the tile finds it way back to the drain. In complete with self - adhesive butyl tape who comes with product represent Anti Leak System.



UNLIMITED ceramic height

Thanks to innovative technical solution of "Unlimited" model, customer can install product on any desired bathroom surface.



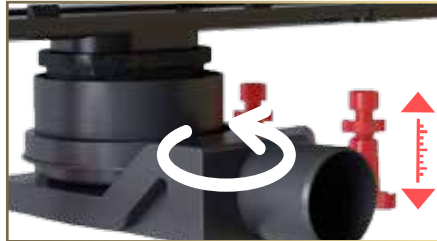

Adjustment of drain height and base position

Universal solution for adjustment of installation height of drain and possibility of rotation of base for 360 degrees.



UNLIMITED drain length

Thanks to the universal solution length of drain can be adjusted from 190mm up to UNLIMITED length.

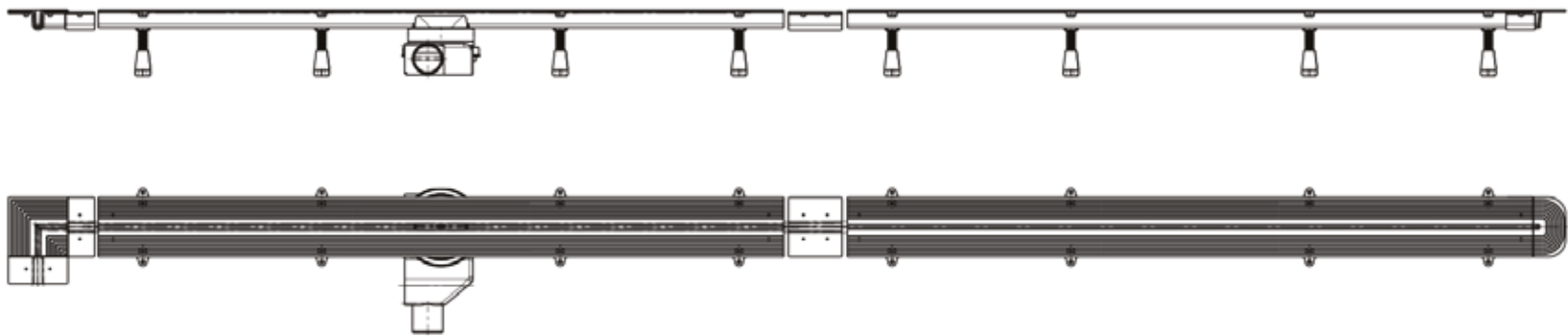



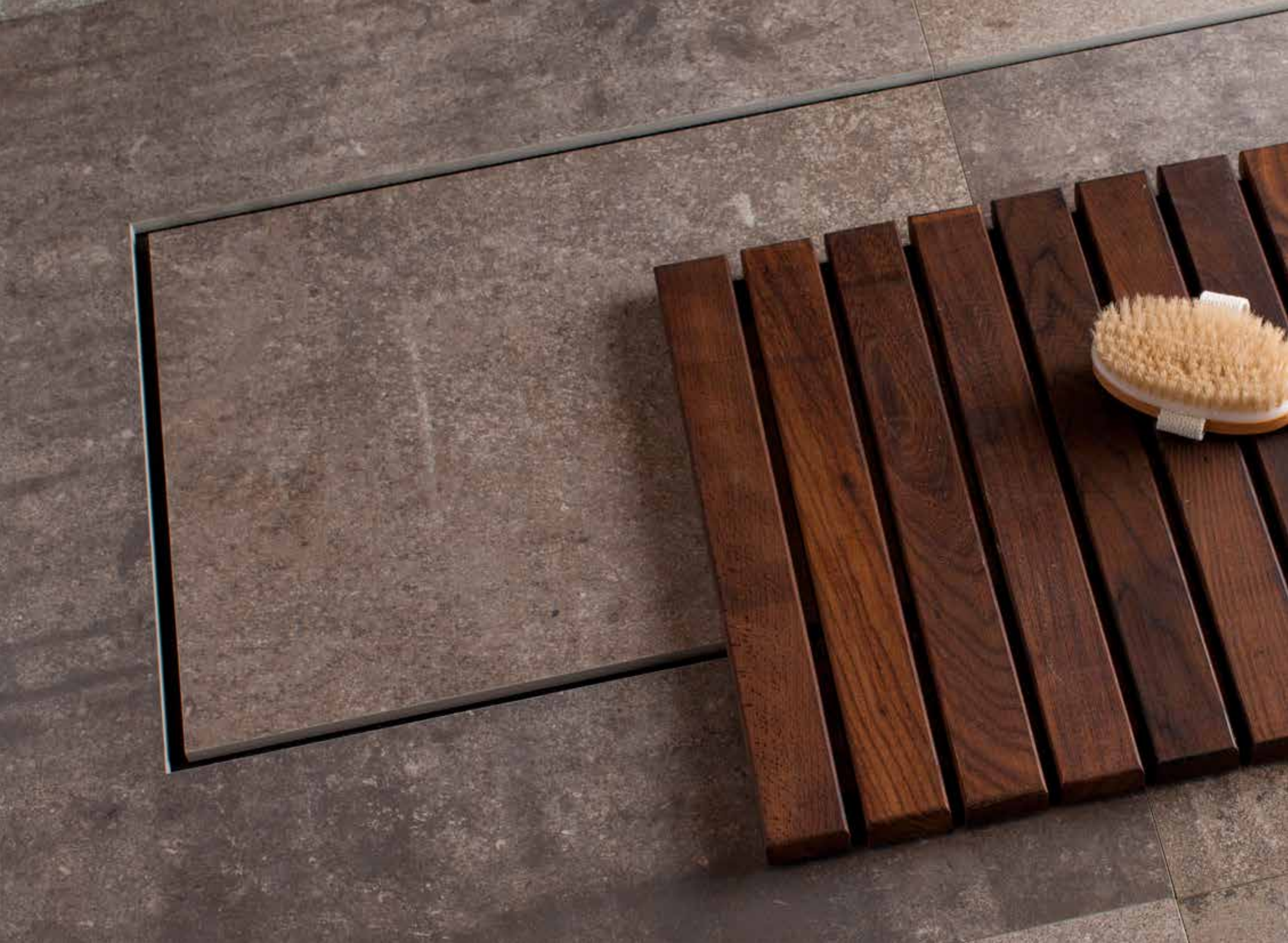

≡ EVO
Unlimited

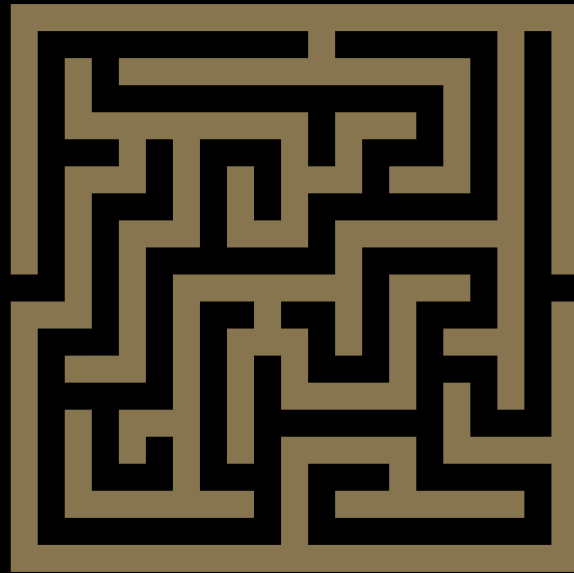

UNLIMITED DESIGN

EVO Unlimited basic design



EVO Unlimited basic design

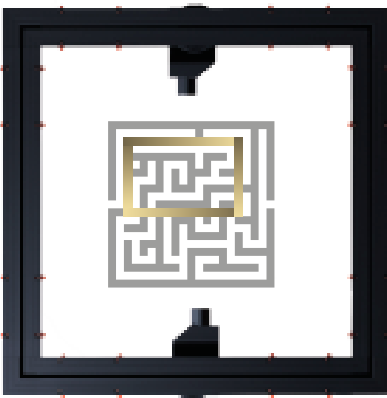

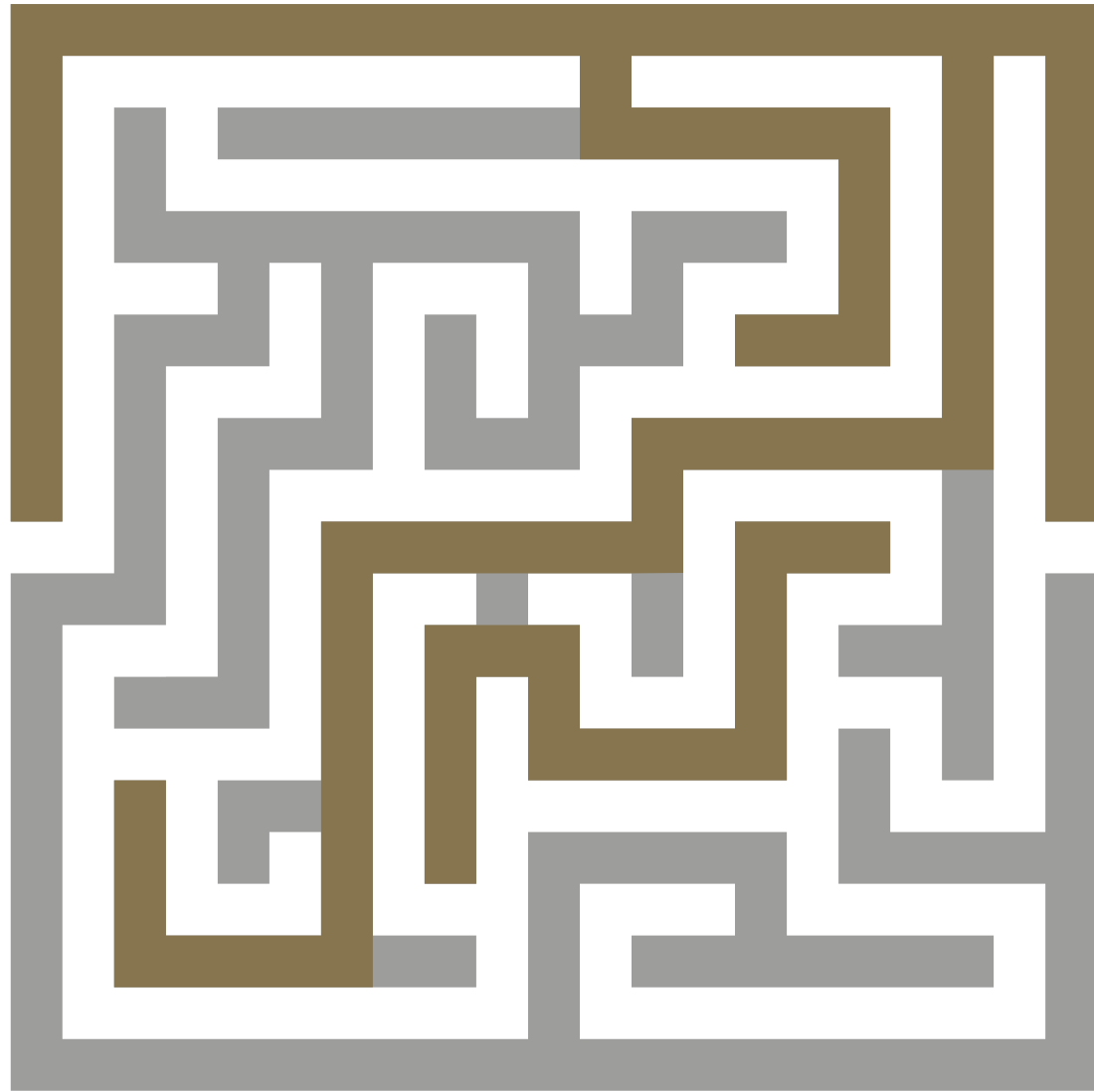

FIND **YOUR DRAIN**
LABYRINTH OF POSSIBILITIES



Drain Instalation

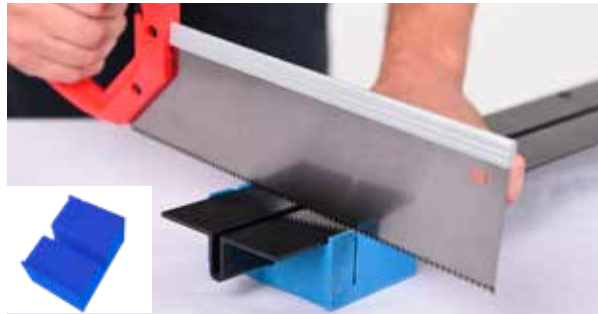

1. CUTTING

Cutting of EVO UNLIMITED shower drain to appropriate size can be done using a cutting kit which is packed with the product. After cutting, it is obligated to do final process of cutted parts.



3. CHANGING DIRECTION OF DRAIN

For changing of direction of drain, you should use angle connector and special glue which comes with product. After infliction of the glue, it is necessary to do additional tightening of connection with screws who comes with the product.



2. GLUING - CONTINUATION OF DRAIN

For continuation of EVO UNLIMITED shower drain until unlimited length, you should use flat connector and special glue which comes with product. After infliction of the glue, it is necessary to do additional tightening of connection with screws who comes with the product.



4. COMPLETION OF DRAIN

For completion of drain, you should use end piece and special glue which comes with product. After infliction of the glue, it is necessary to do additional tightening of connection with screws who comes with the product.



EVO Unlimited Set

EVO Unlimited set contains:

- 2 holder of the grid with vertical output
- 2 holder of the grid without vertical output
- 2 base
- 4 straight connectors
- 4 corner connectors
- 4 ends of drain
- 16 Height adjustment legs
- Set of screws
- Glue

Also all parts can be ordered separately and in combination with cutting kit allows client to have unlimited flexibility regarding shape of drain, surface in bathroom and flow rate.



EVO Unlimited Set Light

EVO Unlimited Set Light contains:

- 1 holder of the grid with vertical output
- 1 base
- 2 ends of drain
- Set of screws
- Glue
- 4 Height adjustment legs

Also all parts can be ordered separately and in combination with cutting kit allows client to have unlimited flexibility regarding shape of drain, surface in bathroom and flow rate.







Content

- Introduction..... 3.
- Evo Icons..... 4.
- Evo Models..... 5.
- EVO Ultra Thin..... 7.
 - Ultra Thin Line..... 11.
 - Ultra Thin Square..... 19.
 - Ultra Thin Wave..... 27.
- EVO Line..... 35.
 - EVO Line Glass White..... 39.
 - EVO Line Glass Black..... 47.
 - EVO Line Invisible..... 55.
 - EVO Line Chrome..... 63.
- EVO Unlimited..... 71.
- Who We Are..... 94.

Who We are

Private company Peštan, leader in the Balkans in the production and distribution of products and solutions from the polymers.

Company was founded in in 1989 and has been producing water pipes made of polyethylene. Over time, we introduced new materials (polypropylene and PVC) and expanded product range. Today, in our offer you may find more than 6500 products, divided into four categories:



**PIPING
SOLUTIONS**



**DRAIN
SOLUTIONS**



**AGRO CULTURE
SOLUTIONS**



**HOUSEHOLD
SOLUTIONS**

+381 034 700 300
OFFICE@PESTAN.NET

1300 KAPLARA 189
ARANĐELOVAC
34300 SRBIJA

WWW.PESTAN.NET