



12dB (A)
Sound Insulation
Level III

Let
the **silence**
be the only
thing you hear

S·LINE

WE ARE

A private Company Peštan, leader in the Balkans in the production and distribution of products and solutions from the polymers.

Company was founded in 1989 and has been producing water pipes made of polyethylene.

Over time, we introduced new materials (polypropylene and PVC) and expanded product range. Today, in our offer you may find more than 6500 products, divided into four categories:



**PIPING
SOLUTIONS**



**DRAIN
SOLUTIONS**



**AGRICULTURE
SOLUTIONS**



**HOUSEHOLD
SOLUTIONS**

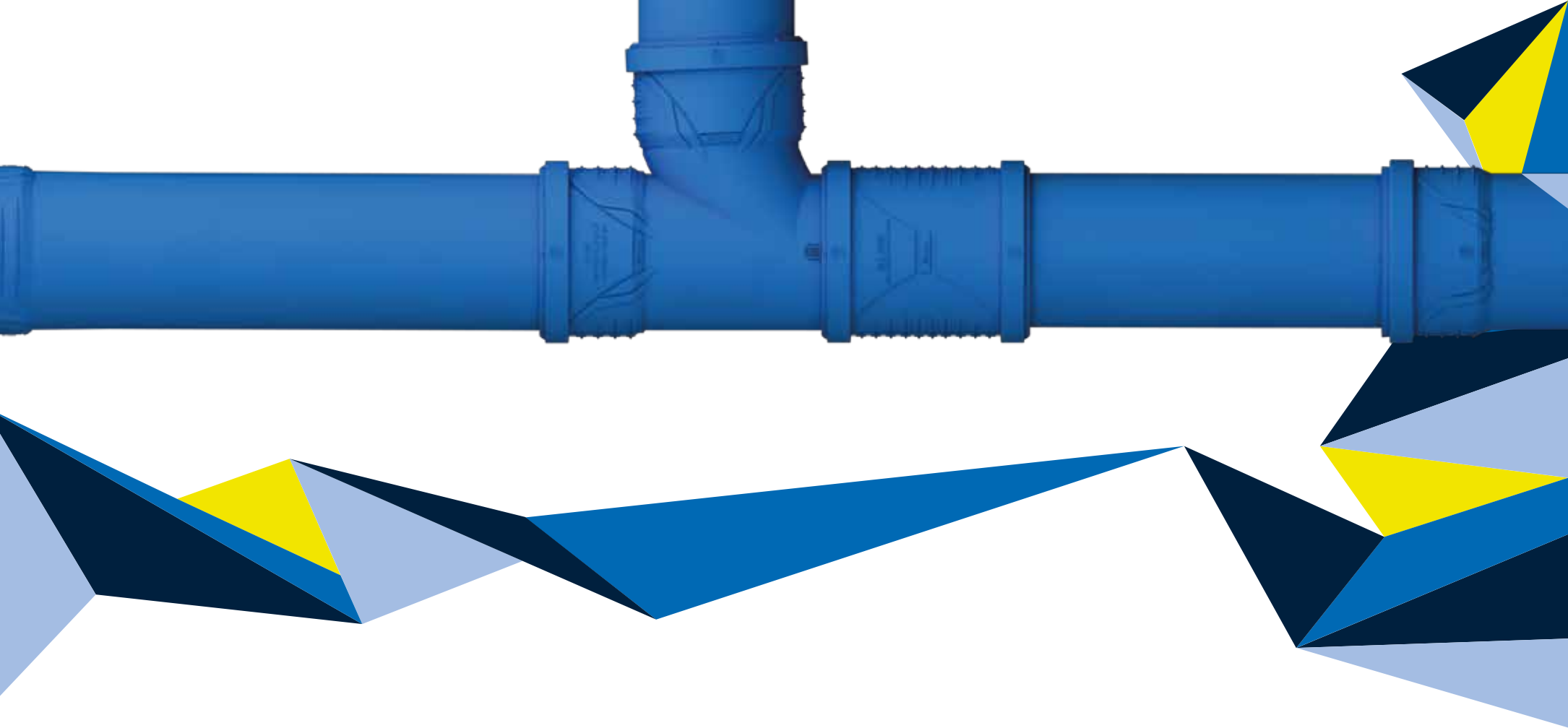

The logo consists of a stylized blue 'S' followed by the word 'LINE' in a bold, blue, sans-serif font.

S·LINE

A large blue pipe system is shown, including a vertical section with an elbow fitting and a horizontal section. The pipes have a textured surface and are connected with flanges. On the left side, there are several overlapping triangles in shades of blue and yellow, some pointing towards the pipe system.

Silent pipes and fittings Ø32 - Ø250

Provides reduction in noise and vibrations up to level of 12dB



S LINE SILENT SEWAGE SYSTEM

The pipes for domestic sewerage systems together with the appropriate coupling sleeves are intended to be used for the removal of all kinds of waste water.

Peštan silent piping system is a promoted version of Peštan HTPP home sewage system and it is specially designed for installation in places where sound insulation is taken into account.

Installed with special pipe clamps (with profiled rubber ring) provides reduction in noise and acoustic vibrations up to level of 12dB(A)*.

The latest technology of three-layer extrusion pipe and materials modified with mineral additives have raised disposal of waste water

systems within the building structure on a higher level.

* LSC,A [dB(A)] Fraunhofer test report P-BA 213/2016e

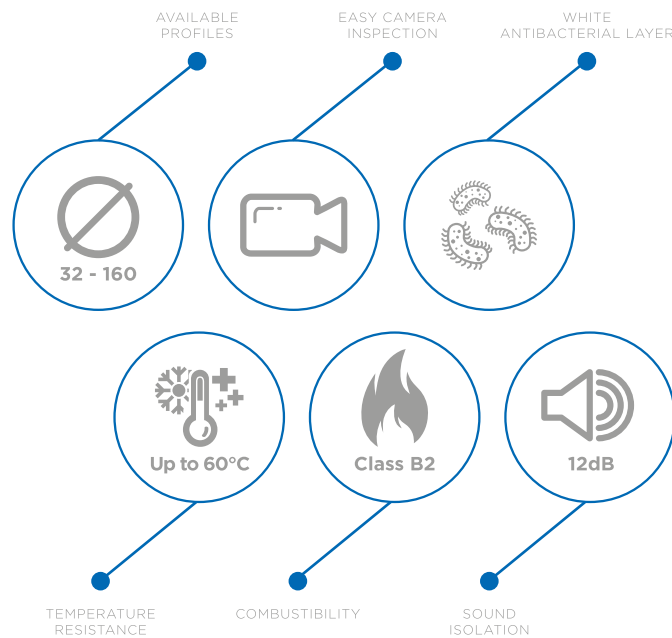

SPECIFICATION OF SILENT PIPES & FITTINGS

Peštan S LINE pipes are consisted of three layers, where each layer contributes to the desired characteristics of the product.

Inner layer: Made of polypropylene copolymer, smooth white inner surface prevents the buildup of sludge and reduces abrasion on the pipes. It allows easy inspection of the pipeline as it is white. It is resistant to high temperatures and chemicals.

Middle layer: Made of polypropylene copolymer and strengthened mineral filler, gives to pipes strength and flexibility.

External layer: Made of polypropylene copolymer, blue. Provides better impact resistance to the pipes, and greater safety when handling and installing products.

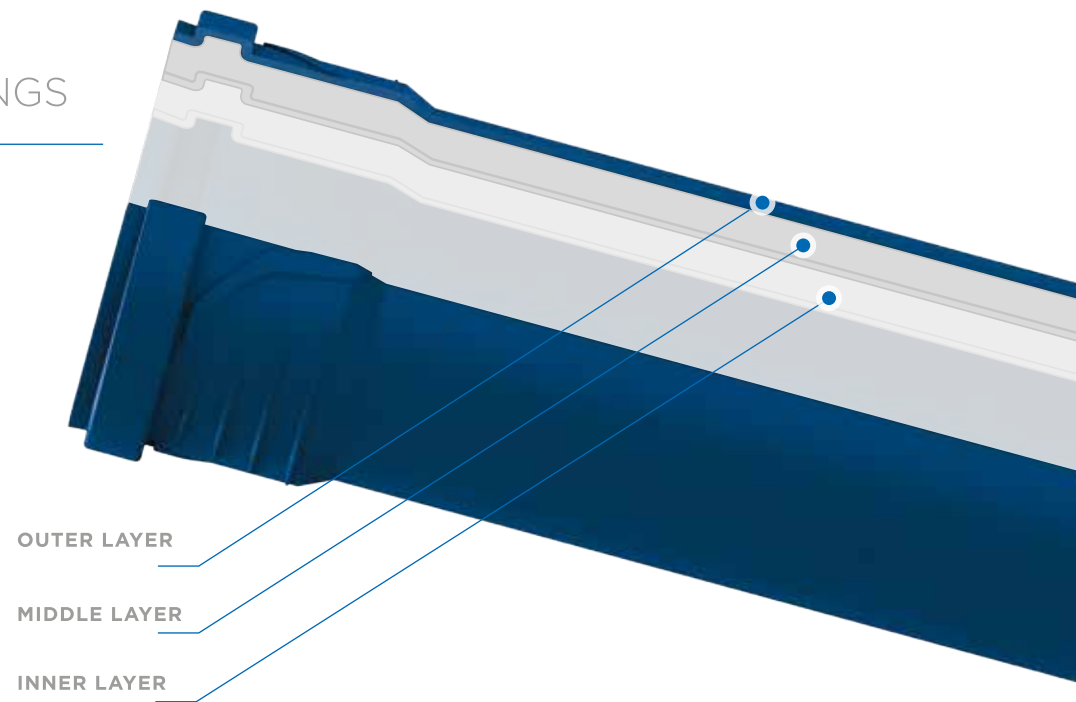

OUTER LAYER

MIDDLE LAYER

INNER LAYER

SUPPORTED STANDARDS:

EN 1451 • EN 1411 • EN 14366 • EN 681 • EN 12056

Material	PP-H (polypropylene copolymer)
Pipe structure	Three-layer composite pipe PPC-PPM-PPC
Density	pipes (Ø32-Ø160) - 1.3 g/cm ³ fitting - 1.4 g/cm ³
Hot water resistance	short term up to 95°C long term up to 60°C
Linear expansion coefficient	0.05 mm/m°C
Chemical resistance	pH 2- pH 12
E - modulus	2400-3100 MPa
Joining method	Push-fit sockets with inserted rubber ring - resistant to leakage up to pressure of 0.5bar
Application category	BD (instalation in buildings and in building construction)
Fire classification	B2 - normal inflamability
Sound insulation level	12 dB(A) sound insulation Level III

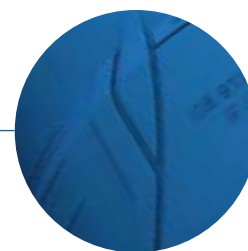

NEW - IMPROVED design of fitting socket



MARKER for determining angle of rotation of the fitting.



REINFORCEMENT ribs for strenghtening the fitting



Peštan logo „**THE HOUSE**” on the bottom of the fitting is used as a marker for the depth of insertion of the fitting into the socket of a pipe or other fitting.

ADVANTAGES OF S LINE PIPES AND FITTINGS

- High thermal, chemical and corrosion resistance
- Good electric insulator
- Simple and easy way of transport and manipulation
- Fast and cheap assembling
- Connection is performed through the socket with inserted rubber ring
- O-rings are made of EPDM rubber (according to EN681).
- White surface of inner layer allows easy inspection of pipe system
- Fully compatible with Pešťan's PVC and HTPP pipes and fittings
- High wear and impact resistance
- Acoustic insulation level 12dB(A) according to EN14366
- Made of a light material with excellent mechanical characteristics
- Practically no costs of pipeline maintenance
- Service life longer than 50 years

250

160

125

110

90

75

50

40

32

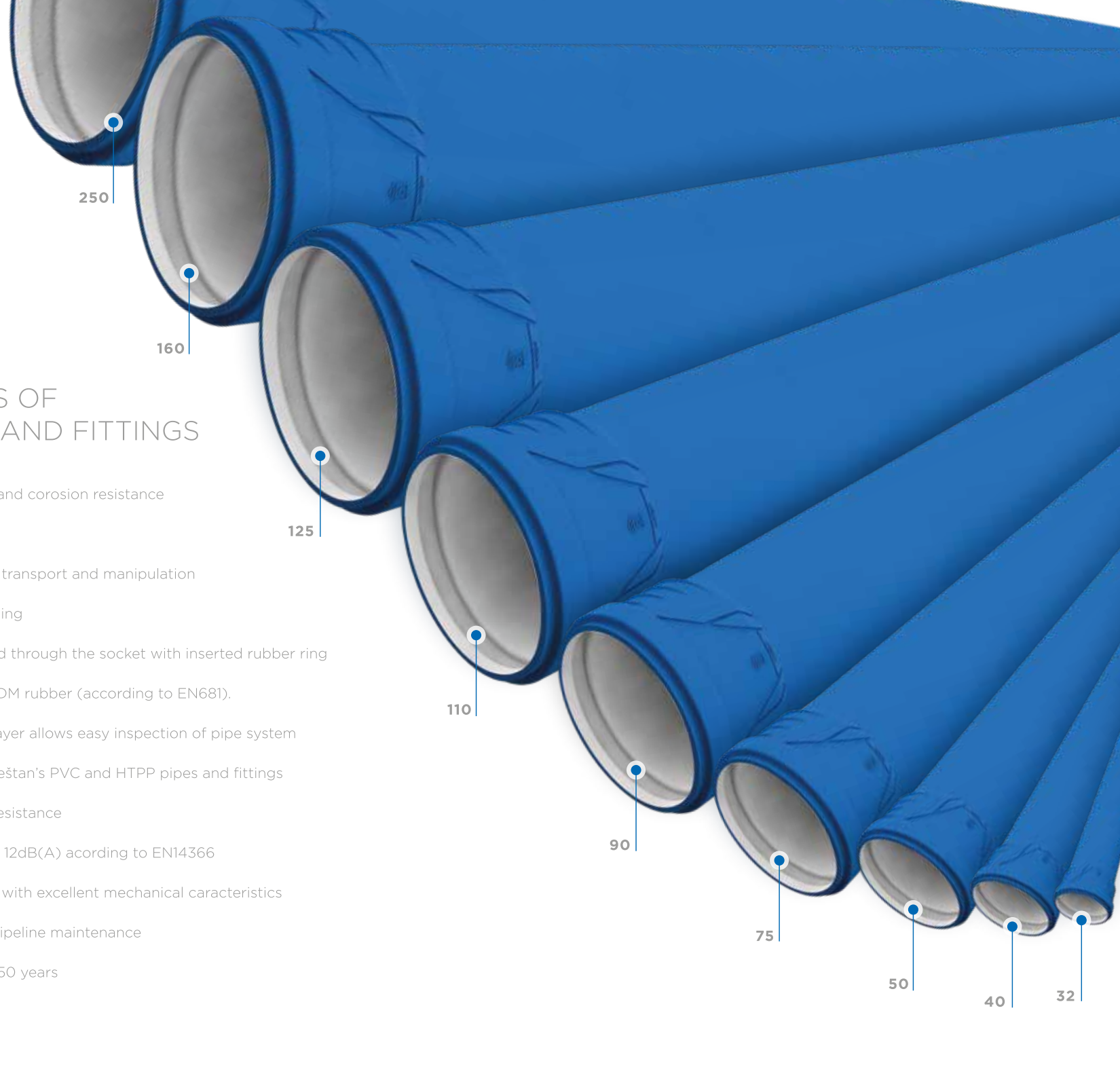



ARC OF DEFLECTION

PEŠTAN S LINE ARCHED T BRANCH

Sound isolation with simple connection of Peštan S LINE arched branches

The system of sewage pipes and fittings with a simple connection, Peštan S LINE system is ideal for fast, economical and acoustically optimized installation of wastewater within the system for drainage and sewerage. It can be used in homes with one or more families as a comprehensive waste water installations or in multi-story buildings intended for business or housing as supply lines (vertical).

Peštan S LINE arched branch, produced in typical dimension for vertical lines, is hydraulically optimized. That way enables greater loads or in some cases smaller dimensions of vertical lines.

Dimensions of Peštan S LINE band branch

- 90/90/87.5°
- 110/90/87.5°
- 110/110/87.5°

Noise isolation

Hydraulically optimized **Peštan S LINE arched branch** in combination with three layer pipes provides higher coefficient of flow and less noise in the sewer pipe. Peštan S LINE system together with **Peštan S LINE arched branch** is perfect for vertical lines and fast multi-level connections which are optimized for noise.

The higher coefficient of flow

Hydraulically optimized geometry of jointing elements of Peštan S LINE system together **Peštan S LINE arched branch** allows economical dimensioning. Smaller dimensions are cheaper and have greater load carrying capacity.

NOISE FROM WASTE WATER INSTALLATIONS

There are two types of noise in waste water installation systems:

- Airborne noise
- Structure-borne noise

Airborne noise

Is consequence of waste water flowing within piping system. With special design of Peštan silent pipes airborne sound is limited and kept inside pipes preventing annoying noise to leave the system.

Structure-borne noise

Are vibrations created by flowing waste water inside pipes. From pipes it is transmitted to pipe clamps and finally to walls of the buildings creating irritating sounds. With special pipe clamps and with correct installation of the pipes this type of noise can be reduced to minimum.

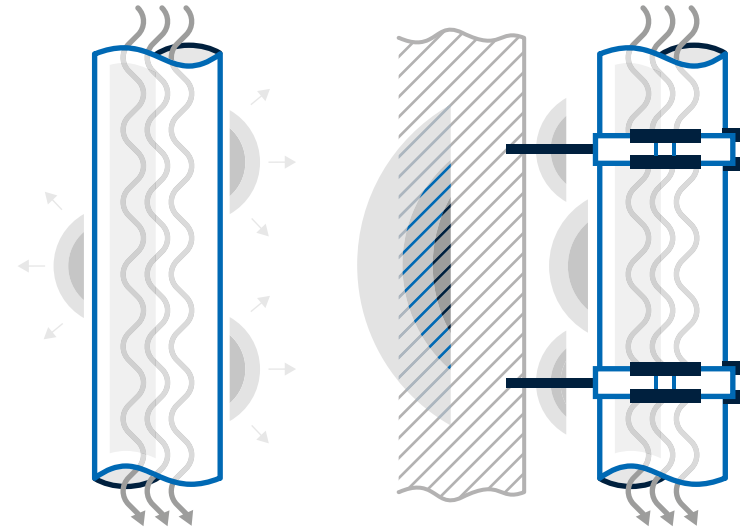

VENTOS

VENTILATION BRANCH

Apliance:

- Waste water drainage in buildings
- For buildings higher then 5 floors
- Six possible ways for connections

Tech. specification

Maximum capacity outflow 17l/s



VERTICAL CONNECTION PIECE FOR VALVES



LEFT

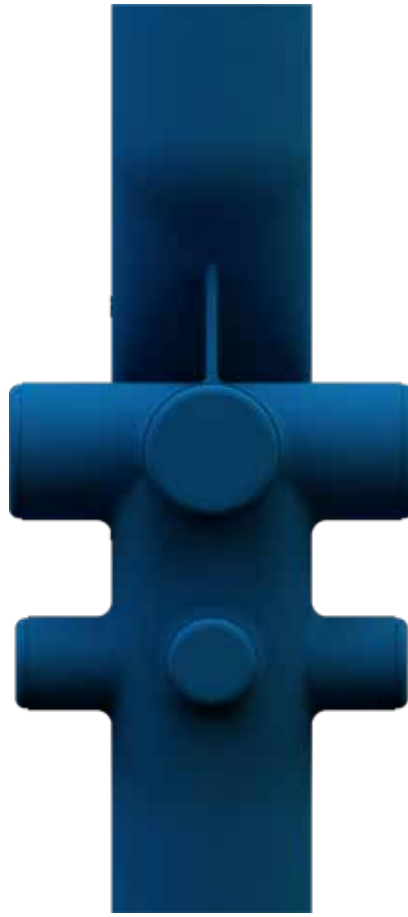

FRONT



RIGHT

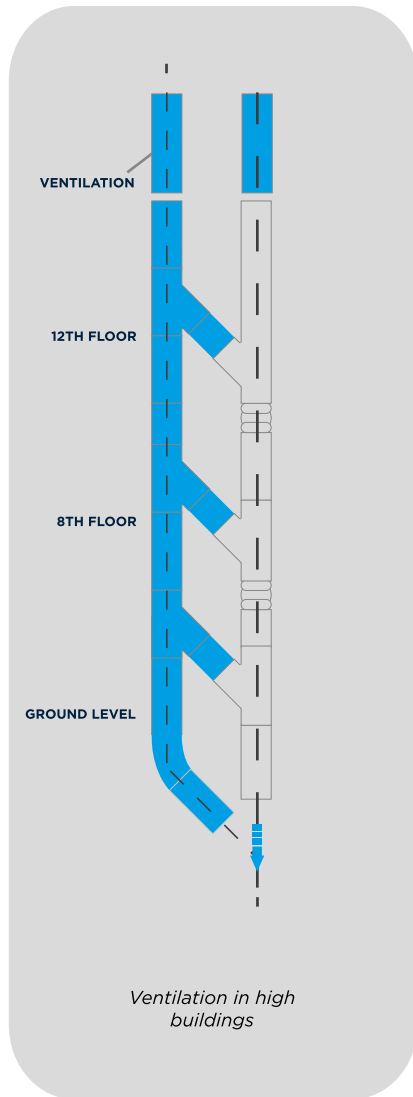

VENTILATION BRANCH

PARALLEL VENTILATION

During the construction of high buildings with traditional verticals the sudden change of pressure can happen in those verticals, that can lead to appearance of the subpressure that can pull the content out of the horizontal pipes attached to the vertical and that can lead to pipe cracking. Also great pressure can blow the content out of the pipes and because of those reasons during the construction the wider verticals are taken into account. Also parallel ventilation that is connected to vertical in regular spacings.

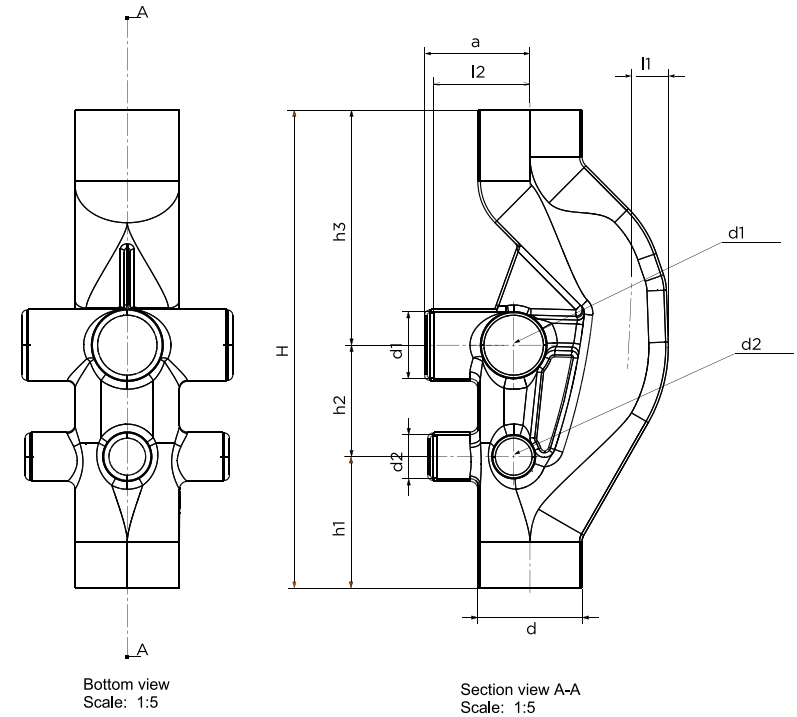

DN	d, Ø	d1 Ø	d2 Ø	a	b	h	h1	h2	l	l1	l2
	[mm]	[mm]	[mm]	[cm]	[cm]	[cm]	[cm]	[cm]	[cm]	[cm]	[cm]
160	160	110	75	13,39	9,5	19	17	35	13	8	11

CONNECTABLE VERTICAL PIECE - PIECE WITH GREATER CAPACITY

OPTIMIZATION OF FLOW IN HIGH BUILDINGS

Peštan vertical piece with greater flow enables increase of the capacity on verticals up to multiple times. Also removes the necessity for creating the parallel ventilation.

MODERN AND ECONOMICAL SOLUTION - REPLACEMENT FOR TRADITIONAL WAY OF DRAINAGE AND VENTILATION

Thanks to Peštan ventilation branch you can let go of traditional ways of projecting and placing of the drainage systems in buildings. Now there is economically and technically reliable solution. Besides that it provides undisturbed flow of the air between horizontal and vertical pipes Peštan ventilation branch removes any possibility of creating of air pockets in the vertical. All this enables projecting and placing of the verticals without creating parallel ventilations which decreases the costs of the constructions.

COMPATIBILITY WITH PEŠTAN SYSTEMS

Peštan ventilation branch is made for verticals in diameters \varnothing 110 and \varnothing 160 with lateral insertions 110 and 75. It is compatible with S-line, HTPP and PVC systems.

TRADITIONAL WAY OF CONNECTING HORIZONTAL FLOOR PIPE AND VERTICAL

When water from vertical pipe reaches the horizontal subpressure can appear that can lead to unwanted consequences such as blow out of the pipe content.

PEŠTAN VENTILATION BRANCH

This hydraulically optimized piece for floor attachments enables that dimensions of verticals be smaller and it eliminates parallel vents which saves time, space and money.

- Modern technical solution
- Economical construction solution
- Increase of vertical capacity
- Compatibility with all Peštan sewage systems



ACOUSTIC INSULATION

According to DIN 4109 noise generated from the pipeline, built-in sound-protected areas should not exceed 35 dB (A). At the same time, the norm VDI 4100 guideline shows that the noise should not exceed 30dB (A). From the above mentioned reasons, Pešťan and its S LINE system were put on testing at the renowned Institute in Stuttgart, where is obtained confirmation of our quality.

According to studies, Pešťan S LINE pipes and related fittings can be classified into LEVEL III of sound insulation with results of 12dB(A)*, obtained in the tests**.

Confirmation of the effective elimination of mentioned problems is done in special acoustic laboratory for measuring noise from wastewater installation systems of Fraunhofer institute Stuttgart. The obtained value from testing of 12dB(A)* makes Pešťan S LINE system suitable for installation on places where sound insulation is taken into account (hospitals, hotels, apartment buildings, universities, libraries, dormitories etc).

* LSC,A [dB(A)] Fraunhofer test report P-BA 213/2016e

** Test was performed on bismat 1000I collars.

Noise level of the PEŠTAN S LINE system in accordance with EN 14366

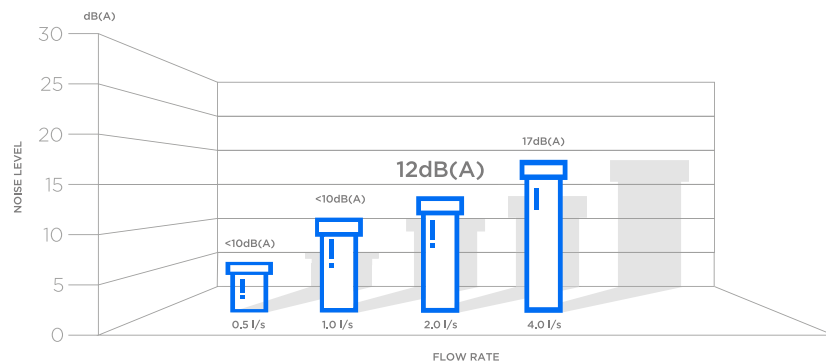

Noise level of the PEŠTAN S LINE system in accordance with VDI 4100

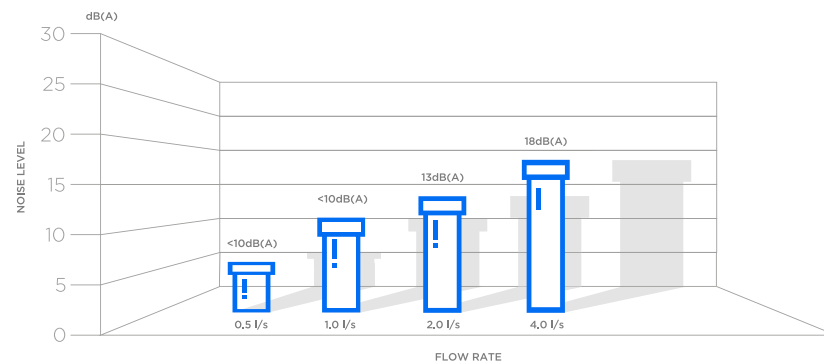

LEVEL OF SOUND ISOLATION AND CALSSIFICATION

According to VDI 4100, there are three levels of sound insulation, depending on the purpose of the facility in which the pipes are installed:

- Level I sound insulation - requirements according to DIN 4109 corresponding to 30 dB (A)
- Level II sound insulation - a higher level of sound insulation corresponds to 25 dB (A)
- Level III sound insulation - the highest level of sound insulation corresponds to 20 dB (A)



VDI sound insulation clasification:

- Level I sound insulation - family houses
- Level II sound insulation - apartment buildings, residential and commercial buildings with few floors
- Level III sound insulation - hotels, hospitals, libraries, reading rooms, residential complexes...



On family houses

Sound insulation level I or on agreement



Apartment buildings, residential and office buildings, comfort apartments

Sound insulation level II or higher



Hotels, hospitals, residential complexes

Sound insulation level III enhanced agreements

Testing of S LINE piping system

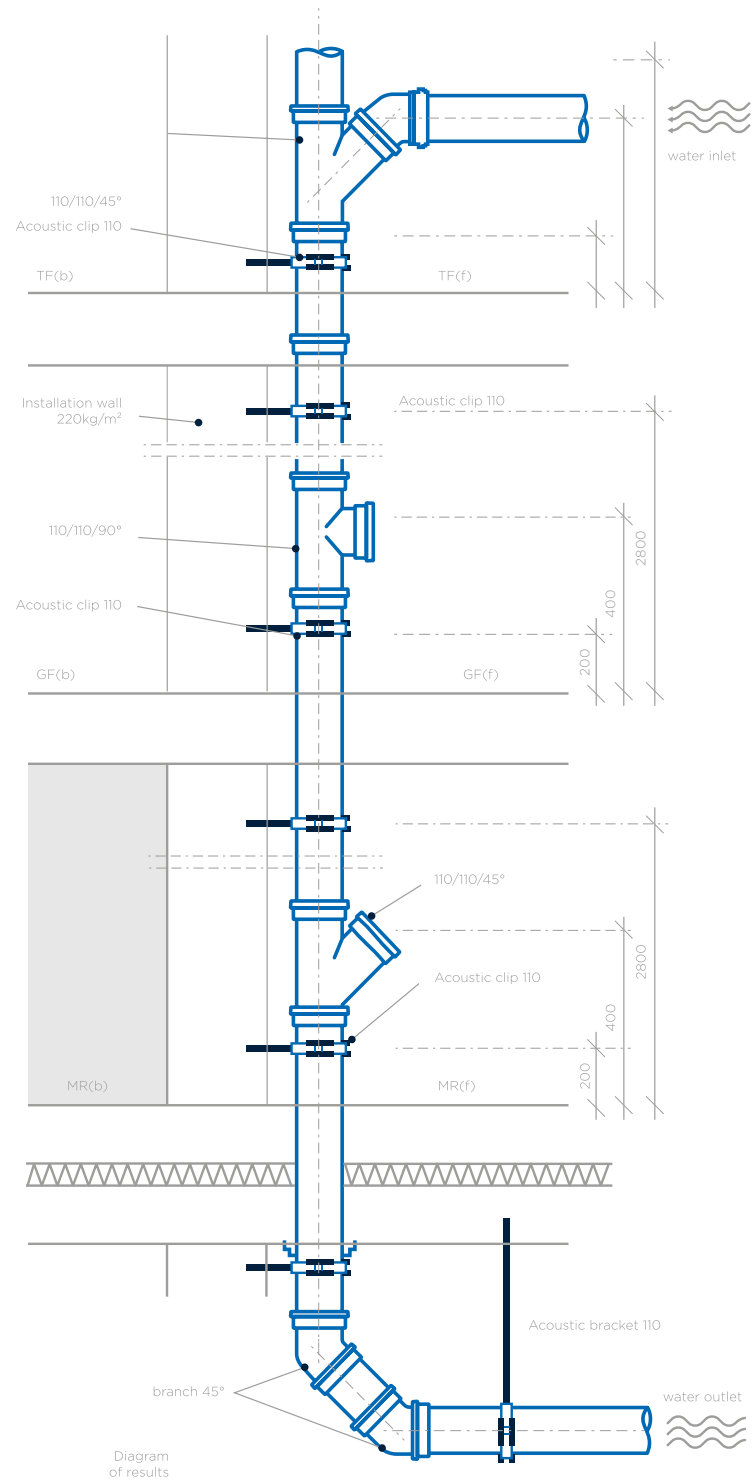

PACKING, STORAGE AND TRANSPORTATION:

All the fittings are packed in cardboard boxes. All pipes are packed in bundles. In order to prevent damage during transport, all Pešťan pipes and fittings must not be transported unpacked and in horizontal position. During unloading they

must be protected against damage, particularly at temperatures below freezing. Never throw, drag or bend pipes and fittings. Pipes should be stored horizontally on even surfaces up to 1.5m high, protected against sunlight.

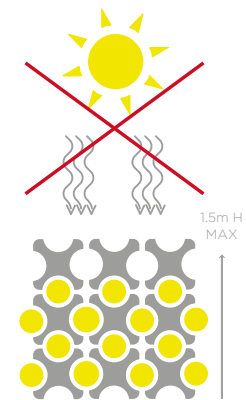
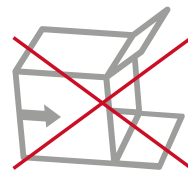
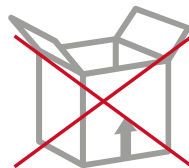
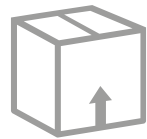

SILENCE IS CLOSER THAN EVER

Peřtan silent system provides reduction in noise and acoustic vibrations up to level of 12dB. Silence and piece in your home is closer than ever

12dB (A)
Sound Insulation
Level III



S LINE PIPES AND FITTINGS PRODUCT RANGE

Pipe with single socket

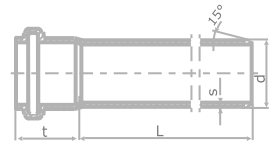

	D	L	S		D	L	S				
10304500		150		10304580		150					
10304501		250		10304581		250					
10304502		500		10304582		500					
10304503		750		10304583		750					
10304504	32	1000	1,8	10304584	90	1000	2,8				
10304505		1500		10304585		1500					
10304506		2000		10304586		2000					
10304507		2500		10304587		2500					
10304508		3000		10304588		3000					
10304509		4000		10304589		4000					
10304520				150				10304600		150	
10304521				250				10304601		250	
10304522		500		10304602		500					
10304523		750		10304603		750					
10304524	40	1000	1,8	10304604	110	1000	3,4+0,4				
10304525		1500		10304605		1500					
10304526		2000		10304606		2000					
10304527		2500		10304607		2500					
10304528		3000		10304608		3000					
10304529		4000		10304609		4000					
10304540				150				10304620		150	
10304541				250				10304621		250	
10304542		500		10304622		500					
10304543		750		10304623		750					
10304544	50	1000	1,8	10304624	125	1000	3,9				
10304545		1500		10304625		1500					
10304546		2000		10304626		2000					
10304547		2500		10304627		2500					
10304548		3000		10304628		3000					
10304549		4000		10304629		4000					
10304560				150				10304640		150	
10304561				250				10304641		250	
10304562		500		10304642		500					
10304563		750		10304643		750					
10304564	75	1000	2,3	10304644	160	1000	4,9				
10304565		1500		10304645		1500					
10304566		2000		10304646		2000					
10304567		2500		10304647		2500					
10304568		3000		10304648		3000					
10304569		4000		10304649		4000					
10304700				500				10304730		500	
10304701				750				10304731		750	
10304702		1000		10304732		1000					
10304703	200	1500	6,2	10304733	250	1500	7,7				
10304704		2000		10304734		2000					
10304705		2500		10304735		2500					
10304706		3000		10304736		3000					
10304707		4000		10304737		4000					

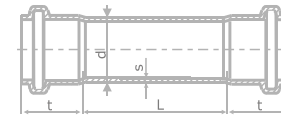

Pipe with double socket

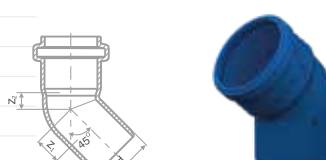

	D	L	S		D	L	S				
10305000		500		10305080		500					
10305001		750		10305081		750					
10305002		1000		10305082		1000					
10305003	32	1500	1,8	10305083	90	1500	2,8				
10305004		2000		10305084		2000					
10305005		2500		10305085		2500					
10305006		3000		10305086		3000					
10305007		4000		10305087		4000					
10305020				500				10305100		500	
10305021				750				10305101		750	
10305022				1000				10305102		1000	
10305023	40	1500	1,8	10305103	110	1500	3,4+0,4				
10305024		2000		10305104		2000					
10305025		2500		10305105		2500					
10305026		3000		10305106		3000					
10305027		4000		10305107		4000					
10305040				500				10305120		500	
10305041				750				10305121		750	
10305042				1000				10305122		1000	
10305043	50	1500	1,8	10305123	125	1500	3,9				
10305044		2000		10305124		2000					
10305045		2500		10305125		2500					
10305046		3000		10305126		3000					
10305047		4000		10305127		4000					
10305060				500				10305140		500	
10305061				750				10305141		750	
10305062				1000				10305142		1000	
10305063	75	1500	2,3	10305143	160	1500	4,9				
10305064		2000		10305144		2000					
10305065		2500		10305145		2500					
10305066		3000		10305146		3000					
10305067		4000		10305147		4000					
10305160				500				10305180		500	
10305161				750				10305181		750	
10305162				1000				10305182		1000	
10305163	200	1500	6,2	10305183	250	1500	7,7				
10305164		2000		10305184		2000					
10305165		2500		10305185		2500					
10305166		3000		10305186		3000					
10305167		4000		10305187		4000					

CODE	DESCRIPTION	PICTURE	Z ₁	Z ₂	L ₁ MIN	D
S LINE BEND 15°						
10304000	Silent bend HTB 32/15°		25	8.45	25	32
10304001	Silent bend HTB 40/15°		26.5	8.97	26.5	40
10304002	Silent bend HTB 50/15°		29.005	8.26	29.005	50
10304003	Silent bend HTB 75/15°		31.79	12.01	37.79	75
10304004	Silent bend HTB 90/15°		33.5	13.83	33.5	90
10304005	Silent bend HTB 110/15°		40.885	16.34	40.885	110
10304006	Silent bend HTB 125/15°		43.84	19.52	43.84	125
10304007	Silent bend HTB 160/15°		47.915	23.05	47.915	160
10304008	Silent bend HTB 200/15°		12.18	27.11	100	200
10304009	Silent bend HTB 250/15°	15.23	34.95	120.5	250	
S LINE BEND 30°						
10304020	Silent bend HTB 32/30°		25	10.4	25	32
10304021	Silent bend HTB 40/30°		26.5	11.5	26.5	40
10304022	Silent bend HTB 50/30°		30.57	11.24	30.57	50
10304023	Silent bend HTB 75/30°		29.5	16.69	29.5	75
10304024	Silent bend HTB 90/30°		33.5	19.58	33.5	90
10304025	Silent bend HTB 110/30°		44.385	21.66	44.385	110
10304026	Silent bend HTB 125/30°		47.81	27.06	47.81	125
10304027	Silent bend HTB 160/30°		53.01	32.43	53.01	160
10304028	Silent bend HTB 200/30°					
10304029	Silent bend HTB 250/30°					
S LINE BEND 45°						
10304040	Silent bend HTB 32/45°		27.88	11.97	27.88	32
10304041	Silent bend HTB 40/45°		30.205	14.64	30.205	40
10304042	Silent bend HTB 50/45°		32.245	14.89	32.245	50
10304043	Silent bend HTB 75/45°		36.705	22.05	36.705	75
10304044	Silent bend HTB 90/45°		42.18	25.7	42.18	90
10304045	Silent bend HTB 110/45°		48.145	30.92	48.145	110
10304046	Silent bend HTB 125/45°		52.075	35.6	52.075	125
10304047	Silent bend HTB 160/45°		58.47	44.24	58.47	160
10304048	Silent bend HTB 200/45°		38.31	55.25	102	200
10304049	Silent bend HTB 250/45°	47.92	69.09	123	250	
S LINE BEND 67,5°						
10304060	Silent bend HTB 32/67,5°		29.645	16.03	29.645	32
10304061	Silent bend HTB 40/67,5°		32.48	18.71	32.48	40
10304062	Silent bend HTB 50/67,5°		35.15	21.03	35.15	50
10304063	Silent bend HTB 75/67,5°		41.125	30.49	41.125	75
10304064	Silent bend HTB 90/67,5°		47.5	36.39	47.5	90
10304065	Silent bend HTB 110/67,5°		54.67	43.68	54.67	110
10304066	Silent bend HTB 125/67,5°		59.475	51.07	59.475	125
10304067	Silent bend HTB160/67,5°		67.955	63.7	67.955	160
10304068	Silent bend HTB 200/67,5°		61.81	80.74	104	200
10304069	Silent bend HTB 250/67,5°	77.31	101.03	125.5	250	

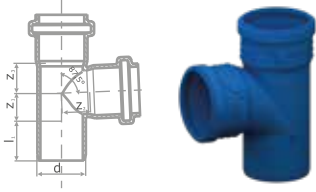
CODE	DESCRIPTION	PICTURE	Z ₁	Z ₂	L ₁ MIN	D	
S LINE BEND 87,5°							
10304080	Silent bend HTB 32/87,5°		31.655	20.09	31.655	32	
10304081	Silent bend HTB 40/87,5°		35.07	23.77	35.07	40	
10304082	Silent bend HTB 50/87,5°		38.46	27.59	38.46	50	
10304083	Silent bend HTB 75/87,5°		46.155	40.69	46.155	75	
10304084	Silent bend HTB 90/87,5°		54.055	48.65	54.055	90	
10304085	Silent bend HTB 110/87,5°		62.1	58.545	62.1	110	
10304086	Silent bend HTB 125/87,5°		67.905	68.15	67.905	125	
10304087	Silent bend HTB 160/87,5°		43	84.73	43	160	
10304088	Silent bend HTB 200/87,5°		88.55	109.48	107	200	
10304089	Silent bend HTB 250/87,5°		110.76	137.98	128.1	250	
CODE	DESCRIPTION	PICTURE	Z ₁	Z ₂	Z ₃	L ₁ MIN	D
S LINE BRANCH 45°							
10304100	Silent branch HTEA 32/32/45°		6.78	47.68	47.6	47.22	32
10304101	Silent branch HTEA 40/32/45°		2.64	54.48	53.64	52	40
10304102	Silent branch HTEA 40/40/45°		8.28	59.24	59.41	49.72	40
10304103	Silent branch HTEA 50/32/45°		2.14	61.09	57.72	48.1	50
10304104	Silent branch HTEA 50/40/45°		3.59	64.95	64.5	55	50
10304105	Silent branch HTEA 50/50/45°		10.36	70.52	70.49	63	50
10304106	Silent branch HTEA 75/40/45°		9.22	84.015	78.12	46.5	75
10304107	Silent branch HTEA 75/50/45°		2.14	88.4	85.84	54	75
10304108	Silent branch HTEA 75/75/45°		15.53	103.97	103.79	70	75
10304109	Silent branch HTEA 90/50/45°		9.64	98.49	90.32	54	90
10304110	Silent branch HTEA 90/75/45°		8.03	113.31	110.37	72	90
10304111	Silent branch HTEA 90/90/45°		18.64	120.98	120.94	81.5	90
10304112	Silent branch HTEA 110/40/45°		26.72	107.36	96.65	42	110
10304113	Silent branch HTEA 110/50/45°		19.64	112.46	120.74	49	110
10304114	Silent branch HTEA 110/75/45°		1.97	127.72	121.75	67	110
10304115	Silent branch HTEA 110/90/45°		8.64	136.75	132.65	76	110
10304116	Silent branch HTEA 110/110/45°		22.78	146.67	145.67	92.5	110
10304117	Silent branch HTEA 125/90/45°		1.14	146.65	140.05	75	125
10304118	Silent branch HTEA 125/110/45°		15.28	159.68	156.64	89	125
10304119	Silent branch HTEA 125/125/45°		25.89	169.58	170.03	100	125
10304120	Silent branch HTEA 160/110/45°		2.22	185.82	174.3	78	160
10304121	Silent branch HTEA 160/125/45°		8.39	193.75	188.78	89	160
10304122	Silent branch HTEA 160/160/45°		33.14	213.57	213.49	114	160
10304123	Silent branch HTEA 200/160/45°		13.14	221.15	215.35	99	200
10304124	Silent branch HTEA 200/200/45°		41.42	240.35	240.35	99.58	200
10304125	Silent branch HTEA 250/160/45°		11.86	253.15	241.53	118.86	200
10304126	Silent branch HTEA 250/200/45°		16.42	277.35	269.53	119.58	200
10304127	Silent branch HTEA 250/250/45°	49.84	301.53	301.53	121.16	200	

CODE	DESCRIPTION	PICTURE	Z ₁	Z ₂	Z ₃	L ₁ MIN	D
S LINE BRANCH 87,5°							
10304130	Silent branch HTEA 32/32/87.5°		15.3	22.51	22.53	47.86	32
10304132	Silent branch HTEA 40/40/87.5°		19.08	27.3	27.62	49.92	40
10304134	Silent branch HTEA 50/40/87.5°		19.96	30.47	27.35	50.06	50
10304135	Silent branch HTEA 50/50/87.5°		23.93	31.37	31.57	52.07	50
10304136	Silent branch HTEA 75/40/87.5°		16.84	42.925	29.66	55.58	75
10304137	Silent branch HTEA 75/50/87.5°		23.39	43.57	35.96	55.47	75
10304138	Silent branch HTEA 75/75/87.5°		35.9	46.23	46.72	56.1	75
10304139	Silent branch HTEA 90/50/87.5°		23.06	51.07	68.31	64.44	90
10304140	Silent branch HTEA 90/75/87.5°		35.57	53.17	47.06	63.63	90
10304141	Silent branch HTEA 90/90/87.5°		43.08	55.3	55.41	63.42	90
10304142	Silent branch HTEA 110/40/87.5°		17.62	61.475	30.465	68.53	110
10304143	Silent branch HTEA 110/50/87.5°		22.62	62.2	35.82	69.4	110
10304144	Silent branch HTEA 110/75/87.5°		35.13	63.11	47.49	69.75	110
10304145	Silent branch HTEA 110/90/87.5°		42.6	63.32	56.25	70.75	110
10304146	Silent branch HTEA 110/110/87.5°		52.65	65.19	65.96	70.84	110
10304147	Silent branch HTEA 125/90/87.5°		42.31	72.485	70.79	73.79	125
10304148	Silent branch HTEA 125/110/87.5°		52.48	75.05	66.48	73.19	125
10304149	Silent branch HTEA 125/125/87.5°	59.83	73.99	74.55	73.17	125	
10304150	Silent branch HTEA 160/110/87.5°	51.67	89.79	70.39	80.45	160	
10304151	Silent branch HTEA 160/125/87.5°	59.07	93.12	77.12	80.06	160	
10304152	Silent branch HTEA 160/160/87.5°	76.58	98.97	98.44	80.42	160	
10304153	Silent branch HTEA 200/160/87.5°	75.71	113.15	97.35	99.29	250	
10304154	Silent branch HTEA 200/200/87.5°	96.08	117.35	117.35	99.27	250	
10304155	Silent branch HTEA 250/160/87.5°	74.62	138.02	103.03	119.38	250	
10304156	Silent branch HTEA 250/200/87.5°	94.99	142.35	122.53	119.36	250	
10304157	Silent branch HTEA 250/250/87.5°	120.26	144.53	144.53	119.34	250	
S LINE BEND BRANCH 87,5°							
10304240	Silent bend branch HTEA 90/90/87.5°		52.13	65.85	53	63.07	90
10304241	Silent bend branch HTEA 110/90/87.5°		49.89	77.35	53.42	74.9	110
10304242	Silent bend branch HTEA 110/110/87.5°		60.53	80.51	61.35	74.54	110

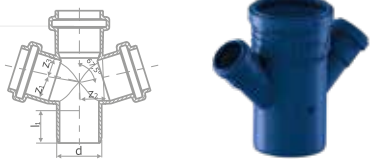
CODE	DESCRIPTION	PICTURE	Z ₁	Z ₂	Z ₃	L ₁ MIN	D
S LINE DOUBLE BRANCH 45°							
10304190	Silent double branch HTDA 50/90/50-45°		25.25	45	25.25	54	90
10304191	Silent double branch HTDA 50/110/50-45°		25.25	55.45	25.25	49	110

S LINE INSPECTION BRANCH							
10304178	Silent inspection branch HTRE 50		25		31.46	51	50
10304179	Silent inspection branch HTRE 75		37.5		46.74	54.5	
10304180	Silent inspection branch HTRE 90		46.44		55.83	62.06	90
10304181	Silent inspection branch HTRE 110		55		66.15	68.5	110
10304182	Silent inspection branch HTRE 125		62.5		75.53	70.5	125
10304183	Silent inspection branch HTRE 160		80		98.78	77	160

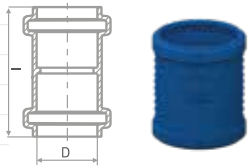
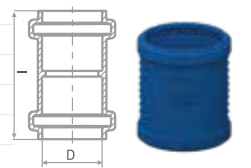
CODE	DESCRIPTION	PICTURE	L	D	DESCRIPTION	PICTURE	CODE	L	D
S LINE DOUBLE SOCKET			S LINE SLIP COUPLER						
10304200	Silent double socket HTM 32		96.9	32.7	Silent slip coupler HTU 32		10304220	96.9	32.7
10304201	Silent double socket HTM 40		104	40.7	Silent slip coupler HTU 40		10304221	104	40.7
10304202	Silent double socket HTM 50		110	50.7	Silent slip coupler HTU 50		10304222	110	50.7
10304203	Silent double socket HTM 75		119	76	Silent slip coupler HTU 75		10304223	119	76
10304204	Silent double socket HTM 90		131	90	Silent slip coupler HTU 90		10304224	131	90
10304205	Silent double socket HTM 110		147	111	Silent slip coupler HTU 110		10304225	147	111
10304206	Silent double socket HTM 125		157	126	Silent slip coupler HTU 125		10304226	157	126
10304207	Silent double socket HTM 160		176	161	Silent slip coupler HTU 160		10304227	176	161
10304208	Silent double socket HTM 200		212	201	Silent slip coupler HTU 200		10304228	212	201
10304209	Silent double socket HTM 250	251	251.5	Silent slip coupler HTU 250	10304229	251	251.5		

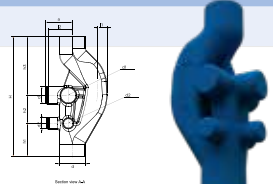
CODE	DESCRIPTION	PICTURE	DN	d, ø	d1 ø	d2 ø	a	b	h	h1	h2	l	l1	l2
VENTOS VENTILATION BRANCH														
40006502	VENTOS VENTILATION BRANCH ø160/ø110/ø75		160	160	110	75	13,39	9,5	19	17	35	13	8	11

CODE	DESCRIPTION	PICTURE	Z1	L1MIN	D	D1
S LINE EXCENTRIC REDUCER						
10304160	Silent reducer HTR 40/32		15.19	54.88	40	32.7
10304161	Silent reducer HTR 32/40		10.435	54.88	40	36.9
10304163	Silent reducer HTR 40/50		17.32	57.88	50	40.7
10304164	Silent reducer HTR 50/40		17.32	57.88	50	40.7
10304165	Silent reducer HTR 75/50		20.94	62.26	75	50.7
10304177	Silent reducer HTR 90/40		19.17	71.16	90	44.9
10304166	Silent reducer HTR 90/50		16.34	70.36	90	54.9
10304167	Silent reducer HTR 90/75		19.1	71.54	90	81
10304168	Silent reducer HTR 90/110		13.025	77.48	110	96.8
10304169	Silent reducer HTR 90/125		13.365	81.51	125	96.8
10304170	Silent reducer HTR 110/40		9.95	77.63	110	44.9
10304171	Silent reducer HTR 110/50		16.89	76.81	110	50.7
10304172	Silent reducer HTR 110/75		19.79	77.54	110	76
10304173	Silent reducer HTR 125/110		19.03	82.63	125	111
10304175	Silent reducer HTR 160/125		22.94	92.09	160	126
10304184	Silent reducer HTR 200/160	27.15	99	200	172	
10304185	Silent reducer HTR 250/200	34.47	120	250	214.6	

CODE	DESCRIPTION	PICTURE	Z1	L1MIN	D	D1
S LINE CAP FOR SOCKET						
10304260	Sline pp Cap for socket ø32 (box)		15.19	54.88	40	32.7
10304261	Sline pp Cap for socket ø40 (box)		10.435	54.88	40	36.9
10304262	Sline pp Cap for socket ø50 (box)		17.32	57.88	50	40.7
10304263	Sline pp Cap for socket ø75 (box)		17.32	57.88	50	40.7
10304264	Sline pp Cap for socket ø90 (box)		20.94	62.26	75	50.7
10304265	Sline pp Cap for socket ø110 (box)		19.17	71.16	90	44.9
10304266	Sline pp Cap for socket ø125 (box)		16.34	70.36	90	54.9
10304267	Sline pp Cap for socket ø160 (box)	19.1	71.54	90	81	

CODE	DESCRIPTION	PICTURE	SIZE D (MM)	L (MM)	L1 (MM)	W (MM)	STD PCK
40006639	S LINE P TRAP,BLUE DN 110 MM		110	167	269	176	10

CODE	DESCRIPTION	PICTURE	SIZE D (MM)	D (MM)	D1 (MM)	H (MM)	H1 (MM)	W	STD PCK
40006640	S LINE FLOOR TRAP,BLUE DN 110/DN75/ DN50 MM		110	75	50	141	50	213	10

CODE	DESCRIPTION	PICTURE	SIZE D (MM)	D (MM)	D1 (MM)	H (MM)	H1 (MM)	W	STD PCK
40006641	S LINE DEEP FLOOR DN110/75/50 MM		110	75	50	175	72	213	10

BRAND MANIFESTO

We do not only sell pipes, we combine reliability with quality for the ultimate benefit of our clients.

We do not build short-term client relationships, but long-term and genuine partnerships.

Everything we do, we do with one thing in mind — to create ideas to perfectly match all our client needs and the best way for us to achieve this goal is to constantly educate our clients provide solutions that meet their specific needs and support them throughout the entire process.

Because our success is as big as your trust in us.



+381 034 700 300
OFFICE@PESTAN.NET

1300 KAPLARA 189
ARANĐELOVAC
34300 SRBIJA

WWW.PESTAN.NET