

PEŠTAN
CONFLUO
SMART DRAINS



WE ARE

We are privately held company Peštan, leader in the Balkans in production and distribution of products and solutions from polymers.

Company was founded in 1989 and has been producing water pipes made of polyethylene. Over time, we introduced new materials (polypropylene and PVC) and expanded product range. Today, in our offer you may find more than 6 500 products, divided into four categories:



**PIPING
SOLUTIONS**



**BATHROOM
SOLUTIONS**



**AGRICULTURE
SOLUTIONS**



**HOUSEHOLD
SOLUTIONS**

“Walk in” showers represent new and elegant solution for bathroom. A barrier-free shower concept inspired and motivated us to create Confluo Smart Drains program. We made our Confluo drains of high quality materials, modular, easy to install and clean, cost effective and with modern design, in order to satisfy all customer needs. With more then 350 different models in our offer, we believe we can meet all their needs.

Dive into our Confluo Drains and discover your new gem in bathroom!

Advantages of Confluo shower drains:

- Huge product portfolio — more than 350 different models
- Modularity
- Modern design
- High functionality
- Best buy products



















Quality and functionality |



Confluo icons

- | | | | |
|--|--|--|--|
| <p>1</p>  | <p>2</p>  | <p>3</p>  | <p>4</p>  |
| <p>Min. installation height</p> <p>Minimal construction height of drain, from bottom of the base, up to the holder of the grid.</p> | <p>Base diameter outlet</p> <p>Diameter of base outlet.</p> | <p>Maximum flow rate</p> <p>Maximum flow rate with 20 mm threshold.</p> | <p>Base inlet diameter</p> <p>Diameter of base inlet.</p> |
| <p>5</p>  | <p>6</p>  | <p>7</p>  | <p>8</p>  |
| <p>Anti-leaking system</p> <p>Anti-Leaking System represents combination of drain construction and proper installation which allows all leaked and condensated water to go back to drain.</p> | <p>2 in 1 system</p> <p>Grid of drain can be turned and used both for stainless steel/gold and ceramic/glass finish.</p> | <p>Base rotation</p> <p>Base of drain can be rotated 360 degrees.</p> | <p>Fine output adjustment</p> <p>Output of drain can be adjusted by 15 degrees.</p> |
| <p>9</p>  | <p>10</p>  | <p>11</p>  | <p>12</p>  |
| <p>Water seal height</p> | <p>Fine ceramic adjustment</p> <p>Model have system for ceramic height leveling, so clients have flexibility in choosing surface in bathroom.</p> | <p>Self-cleaning base</p> <p>Output of drain is constructed in way that whatever goes through grid for hair will for sure go through output and then through sewage system.</p> | <p>Handicapped accessible</p> <p>Easy access to the shower.</p> |
| <p>13</p>  | <p>14</p>  | <p>15</p>  | |
| <p>Material of grid</p> <p>Grid is made of stainless steel AISI 304. Optionally, we can produce grid from stainless steel AISI 316.</p> | <p>Load class of grid</p> <p>Grid is classified as K3, which means that it can withstand 300kg of pressure.</p> | <p>Ceramic adjustment</p> <p>Unlimited ceramic height leveling.</p> | |

Confluo Linear drains

We produce our Confluo Linear drains in 3 different models (Premium Line, Slim Line and Frameless line), 9 different sizes (300, 450, 550, 650, 750, 850, 950, 1050 and 1150 mm) and 3 different grid finishes (Stainless Steel, Glass and Gold). All models, except Slim, have 2 in 1 system where the same model can be used both with Stainless Steel/Gold and Tile/Glass finish and are characterized as ultra low 360 degrees rotatable self-cleaning S base.

Confluo Wall drain

As Peštan Company always follows trends on world market, we have prepared for our customers the latest model in world of shower drains — Wall drain. This model represents innovation in industry and, besides its new and modern design, it is perfect model for renovations and bathrooms with concealed cisterns. Wall drain has body made of plastic and it is supplied with 2 different grids (Stainless Steel and Gold).

Confluo Board

Peštan “Board” program of preinstalled shower drains represents the result of constant searching for better and more efficient solutions for our customers worldwide. With this product, we made a big step ahead concerning waterproofing, safety and aesthetic, as we have minimized possibility of mistake and significantly reduced the time and effort for installation. With this product, as a producer, we have taken responsibility on our side and made modern, quality and time effective solutions for our clients.

Confluo Standard drains

Peštan Company offers to clients more than 150 different models of Confluo Standard drains. All models have body made of plastic and grid made of stainless steel, glass or gold, which we deliver in various designs (Tide, Square, Drops, Black & White Glass, Ceramic and Gold) and sizes (10x10 cm, 15x15 cm and 20x20 cm). Main advantages are: Big variety of models, maximum flow rate, modular and flexible systems with 6 different output, 3 different types of siphons. You can make your own floor drain system easy for installation and maintenance.

Confluo Garden and Roof drains

In our program of outside drainage, we have 2 models — Confluo Top and Confluo Gardino. Confluo Top is used for drainage of water on flat roofs, and Confluo Gardino is made for driveways and garages. Main advantages of this models: Maximum flow rate, modular and flexible system with 4 different outputs, drainage/anti-leaves system, easy installation and maintenance.





Ultra low S base

Main advantages:

1. 360 degrees rotation
2. Superior flow rate — 48 l/min
 - DN 50 mm output
3. Ultra low — 50 mm
4. Acute angle of siphon — 40 degrees
5. Self-cleaning
 - Smooth plastic
 - Wide channel for water, without any obstacles

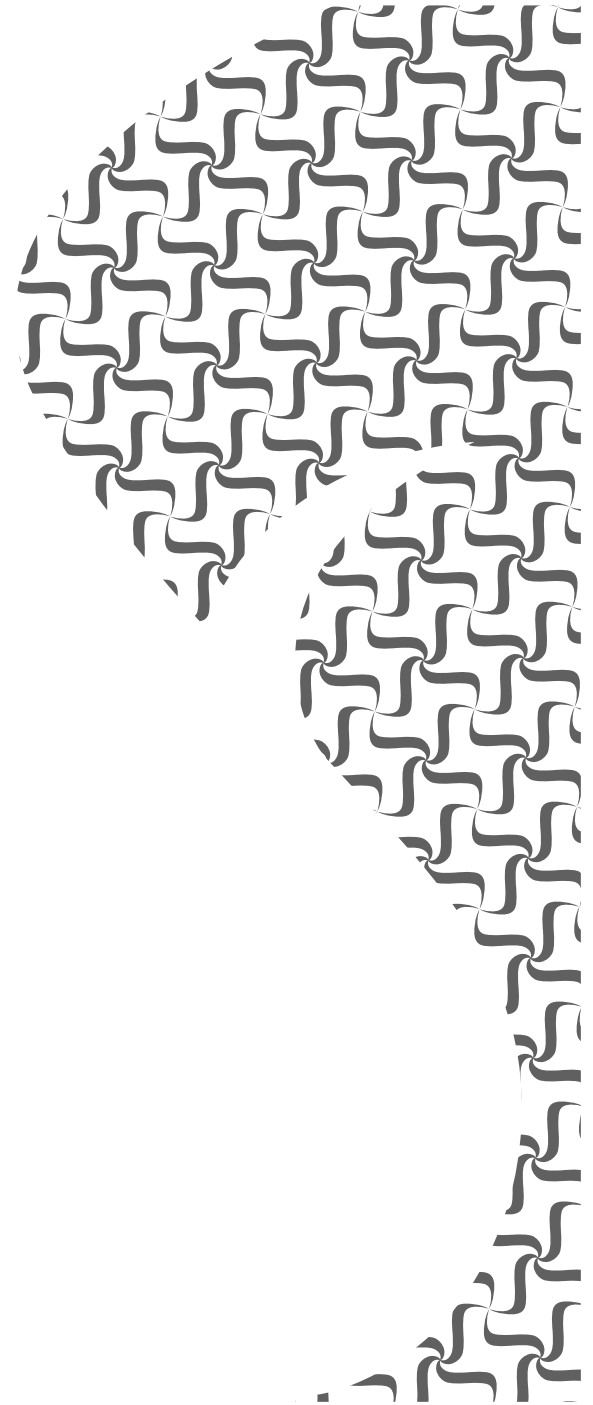



Confluo Wall Drain is an innovative concept in shower drains industry. Possibility of positioning the drain into the wall instead of floor gives your bathroom huge number of possibilities, both technically and design-wise. Model has Anti-Leaking System - ALS, superior flow rate of 48 l/min, minimum installation height of 56 mm and installation depth of 80 mm, which makes this model perfect for bathrooms with concealed cisterns and renovation projects with limited space.

Confluo **Wall** drain

Main advantages:

- Minimum installation height — 56 mm
- Maximum flow rate — 48 l/min
- ALS — Anti-Leaking System
- 360 degrees rotatable self-cleaning S base
- Perfect model for renovations and bathrooms with concealed cistern

Dimensions: 300 mm

Grid Design

Stainless steel

24k GOLD PLATED

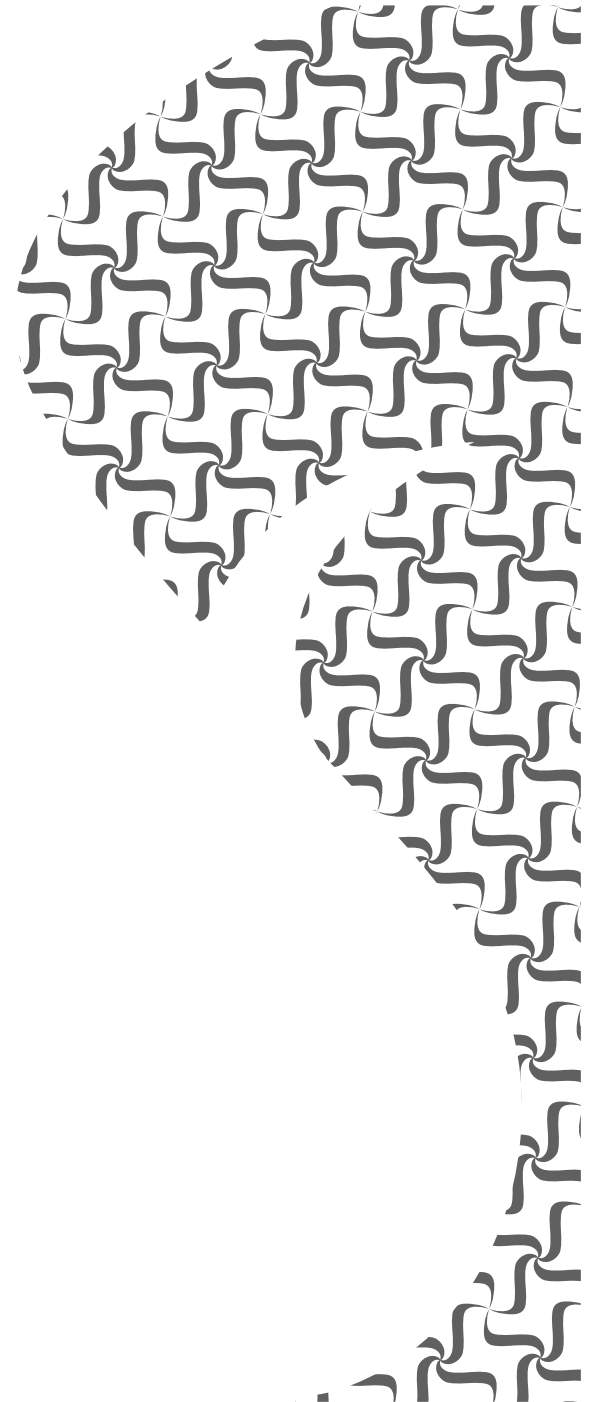



CONFLUO WALL DRAIN

WALL 300



Legend:

1. Ultra low S Base
2. Height adjustment legs
3. Reducer with rubber ring
4. Grid
5. Grid holder
6. ALS chambers
7. Mapei waterproofing butyl tape



Min. installation height

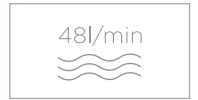

Maximum flow rate



Self-cleaning base

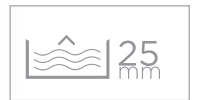

Water seal height



Handicapped accessible



Anti-leaking system



Base diameter outlet



Base rotation

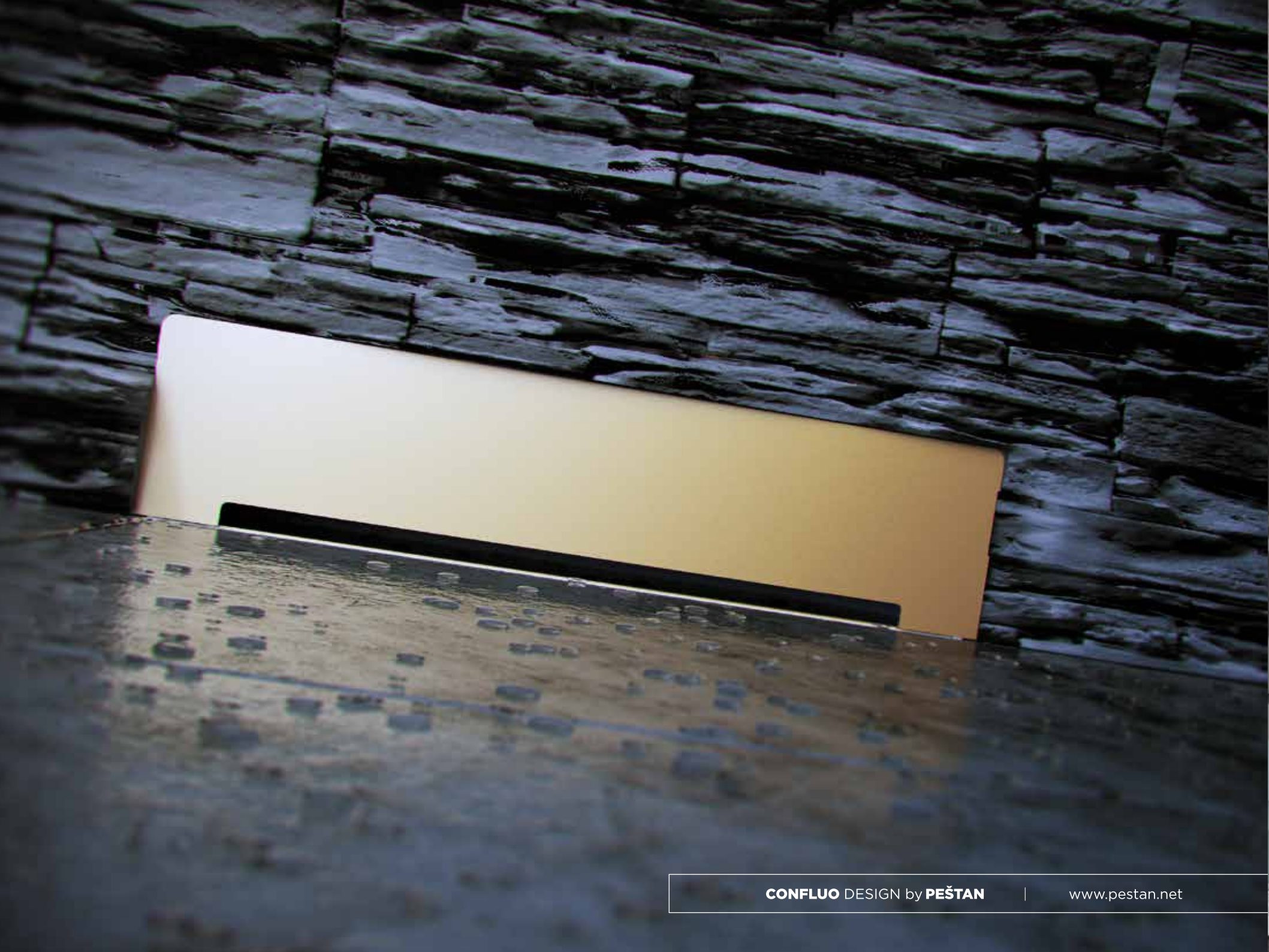

ALS ANTI-LEAKING SYSTEM

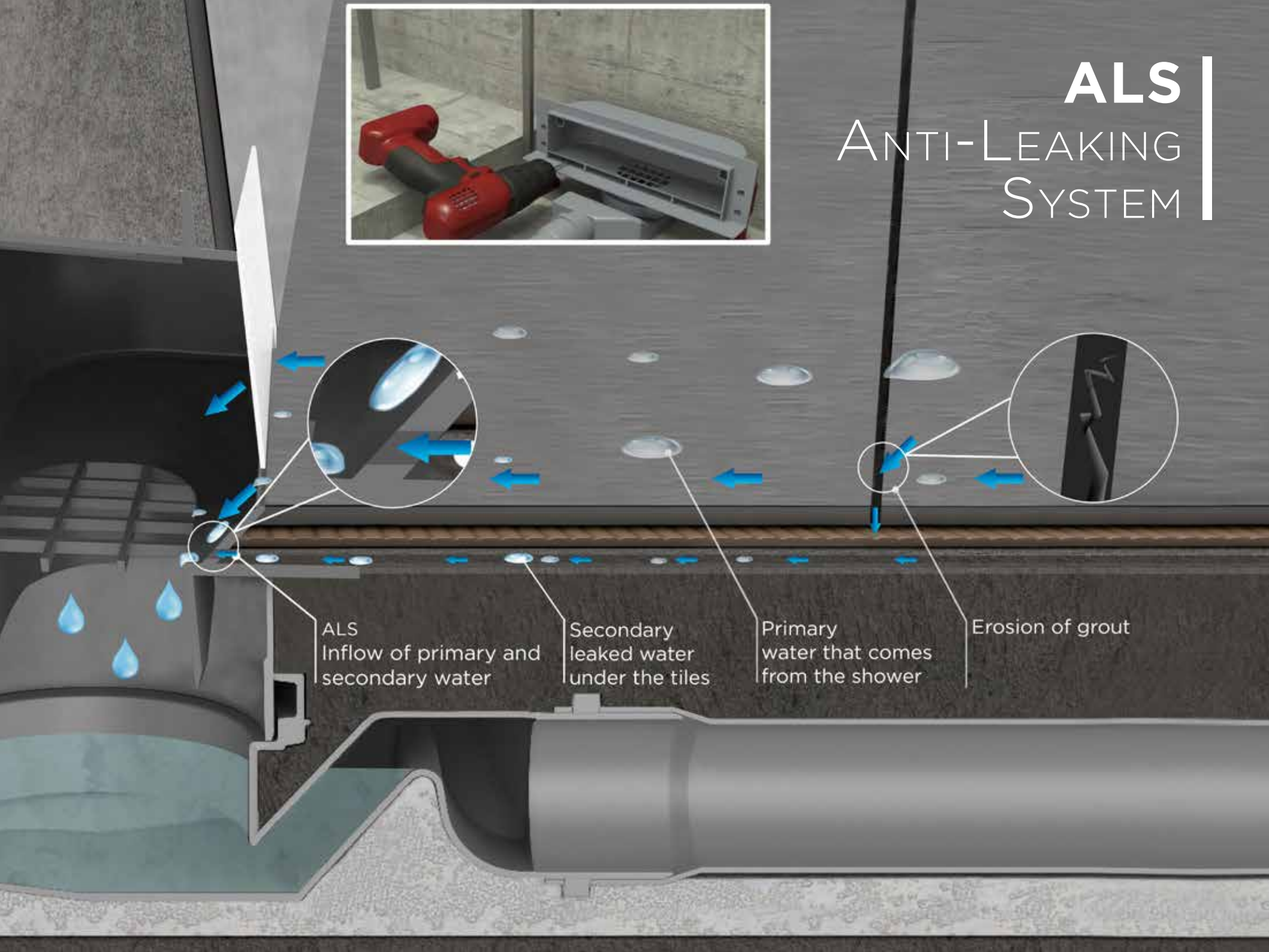

ALS
Inflow of primary and
secondary water

Secondary
leaked water
under the tiles

Primary
water that comes
from the shower

Erosion of grout

Confluo POS Displays



Confluo
Big Display



Confluo Single
Display Premium



Confluo Single
Display Frameless



Confluo Single
Display Slim



Confluo Single
Display Wall

Confluo Webshop Packages

Listening to the needs of our associates, online shop owners, we have created webshop packages with the complete content needed to implement the Confluo range in any online store.

Webshop packages include:

- Photos of installed drains,
- Photographs and rendering of products and all drain elements,
- Text descriptions,
- Technical drawings and technical specifications for all products in the assortment.



Scan QR code for more info and download Confluo webshop packages.



MODULARITY

In order to satisfy the needs of our customers and achieve unlimited flexibility, we created Confluo drains with modular parts, which can be used on multiple products.

Base options:



BASE WITH
1 HORIZONTAL OUTLET



BASE WITH 1 HORIZONTAL
OUTLET/1 INLET



BASE WITH 1 HORIZONTAL
OUTLET/3 INLETS



VERTICAL BASE



S BASE WITH 28 MM OF WATER
SEAL AND ADJUSTABLE OUTPUT

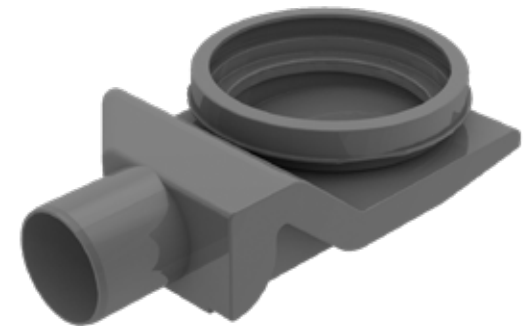

ULTRA LOW S BASE WITH
25 MM OF WATER SEAL

ADAPTERS



5 cm water seal adapter as per EN 1253



USA 2" vertical adapter for American plumbing p-trap systems made of ABS and PVC.



MENA DN 90, 75, 63, 50, 40 mm vertical adapter made of PP for plumbing systems with siphon in dropped ceiling.



MENA DN 50 MM VERTICAL ADAPTER







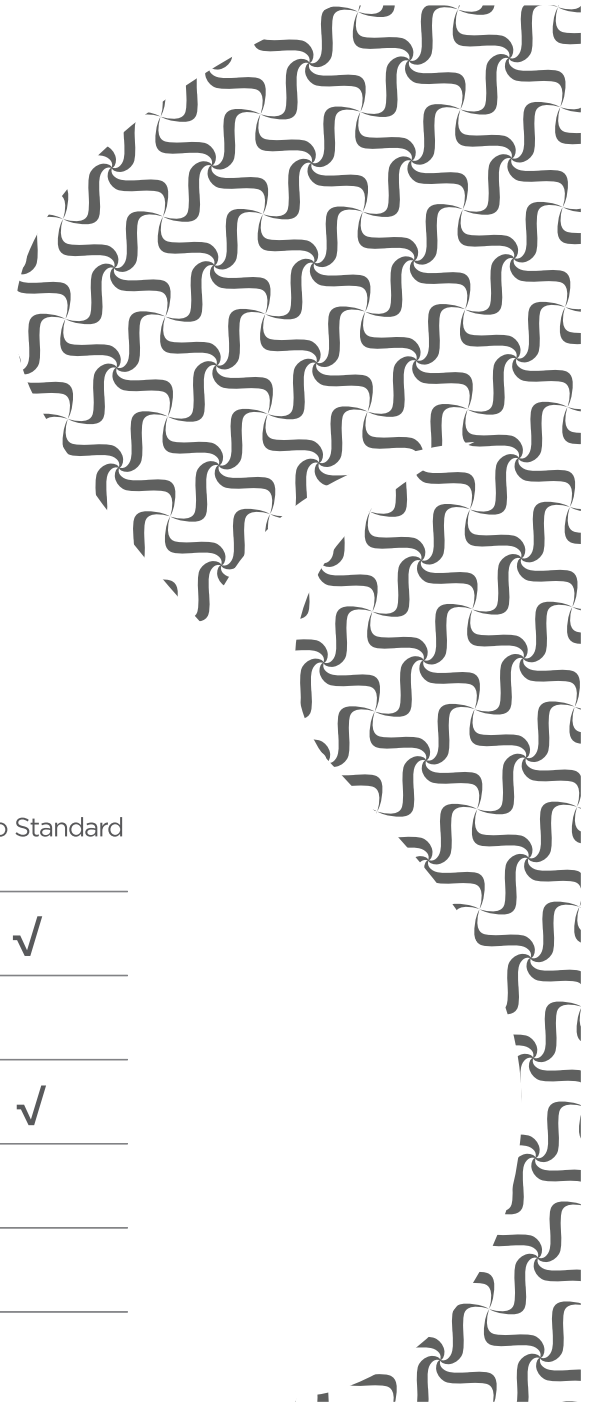

MENA DN 100 MM ADAPTER



HORIZONTAL S BASE 5 CM WATER SEAL



Compatibility of adapters with Confluo models:

	Confluo Premium Line	Confluo Frameless Line	Confluo Slim Line	Confluo Wall Drain	Confluo Standard
	✓	✓			✓
	✓	✓	✓	✓	
	✓	✓	✓	✓	✓
	✓	✓	✓	✓	
	✓	✓	✓	✓	
	✓	✓	✓	✓	

BRAND MANIFESTO

We do not only sell pipes, we combine reliability with quality for the ultimate benefit of our clients.

We do not build short-term client relationships, but long-term and genuine partnerships.

Everything we do, we do with one thing in mind — to create ideas to perfectly match all our client needs and the best way for us to achieve this goal is to constantly educate our clients provide solutions that meet their specific needs and support them throughout the entire process.

Because our success is as big as your trust in us.



+381 034 700 300
OFFICE@PESTAN.NET

1300 KAPLARA 189
ARANDELOVAC
34300 SRBIJA



WWW.PESTAN.NET