

A large elephant is standing on a large, reddish-brown pipe that lies horizontally across the foreground. The elephant is facing right, with its trunk slightly curled. The background is a misty savanna landscape with large, flat-topped rock formations under a grey, overcast sky. The overall tone is muted and atmospheric.

 **PEŠTAN**  
we build trust

Proven **strenght.**  
High level of **durability.**

**PPSTRONG**  
pipes and fittings



# WE ARE

We are privately held company Peštan, leader in the Balkans in production and distribution of products and solutions from polymers.

Company was founded in 1989 and has been producing water pipes made of polyethylene. Over time, we introduced new materials (polypropylene and PVC) and expanded product range. Today, in our offer you may find more than 6500 products, divided into four categories:



**PIPING  
SOLUTIONS**



**DRAIN  
SOLUTIONS**



**AGRICULTURE  
SOLUTIONS**



**HOUSEHOLD  
SOLUTIONS**

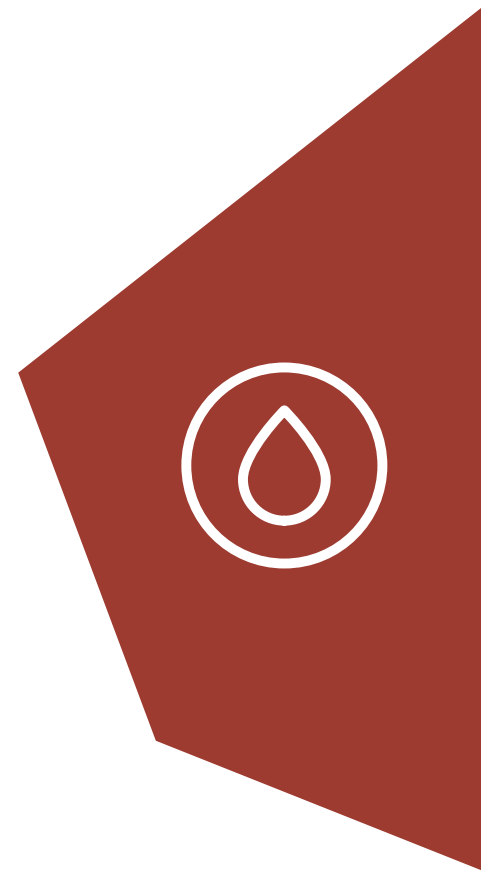

# PP STRONG pipes and fittings

---

Peštan PP Strong pipes and fittings are produced of PP material by the newest technology of pipe extrusion and fitting injection. PP STRONG pipe system for all kinds of waste water is made as homogeneous fully-walled pipe without mineral additives with extremely smooth inner surface according to EN 1852.

Both pipe and fitting in the PP STRONG range are intended for areas with great static pressure, such as airports, highways and railroads. PP STRONG system is universal and can be used for removing all types of waste waters in low construction.

Installation and manipulation of the pipeline elements is very simple and is described in the following chapters of this technical manual. Pipes are connected with fittings, while the waterproofing in connections is provided by rubber rings (safety lock) made of EPDM rubber with plastic reinforcement. Inner layer of PP STRONG pipe is very smooth, which results with excellent hydraulic characteristics, high resistance to abrasion, and preventing subsidence on inner layer of the pipe.

PP STRONG pipes are resistant to corrosion and their life span is 50 years if used properly.

PP STRONG pipes are resistant to corrosion and their life span is 50 years if used properly.

Pipes and fitting have excellent thermal stability and are resistant to:

-Short term exposure up to 90°C

-Continuous thermal exposure up to 60°C

Chemical resistance of PP STRONG:

Salt water, alcohol, acids, alkali, sulphates, aggressive gases and all kinds of detergents. They are well suited for drainage of aggressive chemical wastes, Ph values between 2 and 12.

PP STRONG is sensitive to waste waters that contain high percentage of gasoline, benzene and acetone. For detailed chemical resistance of pipeline please consult the table on our web page.

Fittings are 100% resistant to leaking up to the pressure of 0.5bar with usage of classic rubber ring of EPDM rubber. While using the special safety lock rubber with plastic reinforcement, leaking resistance goes up to 2bar short term.

Pipes aren't intended for outside appliance because of the instability to UV radiation. PP STRONG is intended for underground appliance and under great loads. Do not install the pipeline in temperature below 5°C.

PP STRONG goes under the B2 class of fire stability by standard DIN 4102, they belong to the group of normal burning materials.

### CHARACTERISTICS:

- Absolute impermeability
- Minimal wasting
- Stable functioning during the whole life span of the pipe
- Higher ring stiffness
- Higher longitudinal rigidity
- Available pipe with coupling or with integrated socket
- High ring flexibility

### ADVANTAGES:

- Wide range of fittings
- Great resistance to static and dynamic pressures
- Great resistance to work damage
- High impact resistance
- Without mineral additives
- Stability to chemical and thermal pressure
- Very tight lock in connections
- Very long term life

### FIELDS OF APPLIANCE:

- Communal drainage
  - New buildings or replacements of old sewage
- Chemical and machine industry
  - Excellent chemical stability (ph 2-12)
- Food industry
  - Great stability to temperatures and cycle work resistance
  - Stability to cleaning products
- Roads
  - Great resistance to static and dynamic loads and pressures

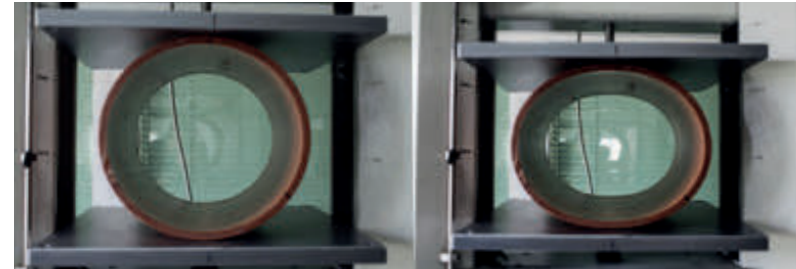

Pipes withstand deformations up to 30% to inner diameter. According to EN ISO 13968



# PP STRONG pipes

---

Peštan PP STRONG pipes and fittings are produced in:

- Diameters Ø110 to Ø500
- Ring stiffnesses SN4, SN8, SN10, SN12, SN16 in accordance EN1852

PP STRONG pipes are produced in standard lengths 1 - 6m.

PP STRONG in classes SN4, SN8, SN10 and SN12 are produced with socket, while class SN16 are produced with integrated coupling.

PP STRONG coupling stiffness class is SN16 and as such resistant to big static pressures.

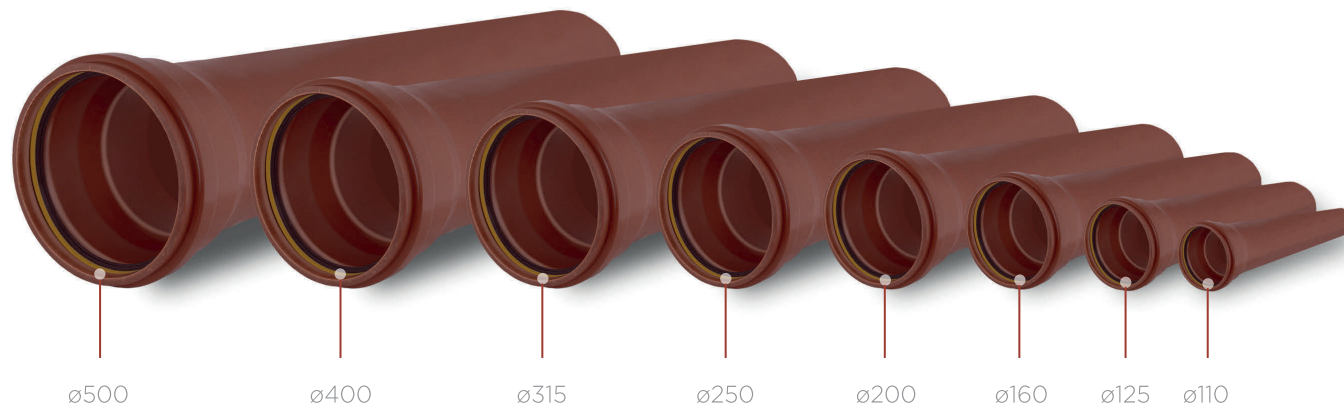

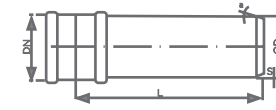
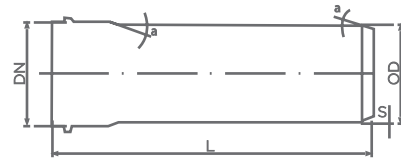

SN 4			SN 8			SN 10			SN 12			SN 16		
DN [mm]	S [mm]	L [mm]	DN [mm]	S [mm]	L [mm]	DN [mm]	S [mm]	L [mm]	DN [mm]	S [mm]	L [mm]	DN [mm]	S [mm]	L [mm]
110	3,4	1000	110	3,8	1000	110	4,2	1000	110	4,5	1000	110	5	1000
		3000			3000			3000			3000			3000
		6000			6000			6000			6000			6000
125	3,9	1000	125	4,3	1000	125	4,8	1000	125	5,1	1000	125	5,7	1000
		3000			3000			3000			3000			3000
		6000			6000			6000			6000			6000
160	4,9	1000	160	5,5	1000	160	6,2	1000	160	6,5	1000	160	7,3	1000
		3000			3000			3000			3000			3000
		6000			6000			6000			6000			6000
200	6,2	1000	200	6,9	1000	200	7,7	1000	200	8,1	1000	200	9,1	1000
		3000			3000			3000			3000			3000
		6000			6000			6000			6000			6000
250	7,7	1000	250	8,6	1000	250	9,6	1000	250	10,2	1000	250	11,4	1000
		3000			3000			3000			3000			3000
		6000			6000			6000			6000			6000
315	9,7	1000	315	10,8	1000	315	12,1	1000	315	12,8	1000	315	14,4	1000
		3000			3000			3000			3000			3000
		6000			6000			6000			6000			6000
400	12,3	1000	400	13,7	1000	400	15,4	1000	400	16,3	1000	400	18,2	1000
		3000			3000			3000			3000			3000
		6000			6000			6000			6000			6000
500	15,3	1000	500	17,1	1000	500	19,2	1000	500	20,3	1000	500	22,8	1000
		3000			3000			3000			3000			3000
		6000			6000			6000			6000			6000

# PP STRONG pipes with socket

---

The tubes are produced in ring stiffness of: SN4, SN8, SN10, SN12.

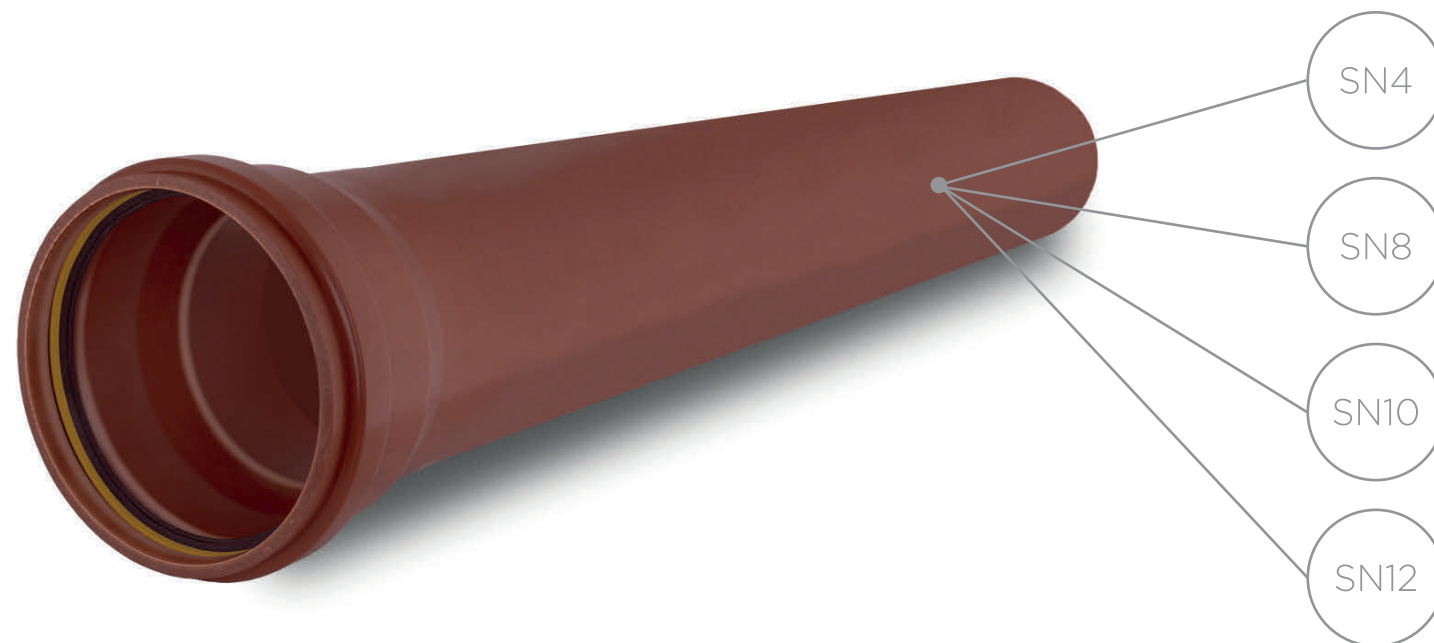

## PIPE MARKING

EAN, Peštan logo, PP DN\_OD SDR EN1852 SN PP Strong CT UD [www.pestan.net](http://www.pestan.net) SRB date time \*



SDR 24,6 SN12				
DN/OD	emin	Amin	Bmin	d3,min
110	4,5	40	6	120,3
125	5,1	43	7	137,1
160	6,5	50	9	173,8
200	8,1	58	12	215,6
250	10,2	68	18	272,9
315	12,8	81	20	338,9
400	16,3	98	24	427,1
500	20,3	118	28	533,2

SDR 33 SN 4				
DN/OD	emin	Amin	Bmin	d3,min
110	3,4	40	6	120,3
125	3,9	43	7	137,1
160	4,9	50	9	173,8
200	6,2	58	12	215,6
250	7,7	68	18	272,9
315	9,7	81	20	338,9
400	12,3	98	24	427,1
500	15,3	118	28	533,2

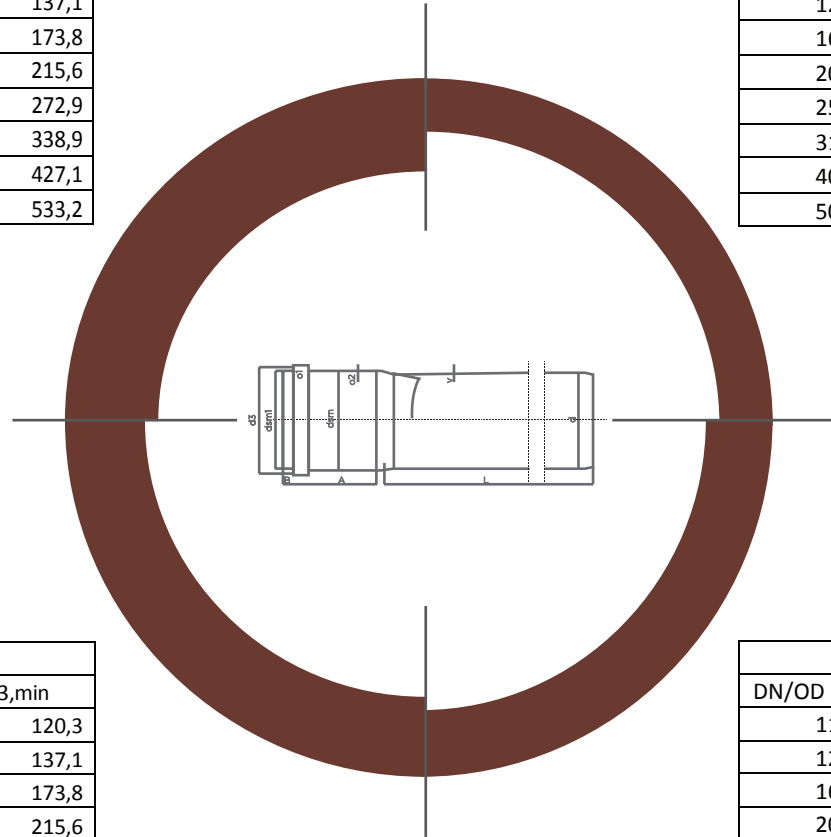

SDR 26 SN10				
DN/OD	emin	Amin	Bmin	d3,min
110	4,2	40	6	120,3
125	4,8	43	7	137,1
160	6,2	50	9	173,8
200	7,7	58	12	215,6
250	9,6	68	18	272,9
315	12,1	81	20	338,9
400	15,4	98	24	427,1
500	19,2	118	28	533,2

SDR 29 SN8				
DN/OD	emin	Amin	Bmin	d3,min
110	3,8	40	6	120,3
125	4,3	43	7	137,1
160	5,5	50	9	173,8
200	6,9	58	12	215,6
250	8,6	68	18	272,9
315	10,8	81	20	338,9
400	13,7	98	24	427,1
500	17,1	118	28	533,2

# PP STRONG pipes with integrated coupling

The tube is produced in ring stiffness of: SN16

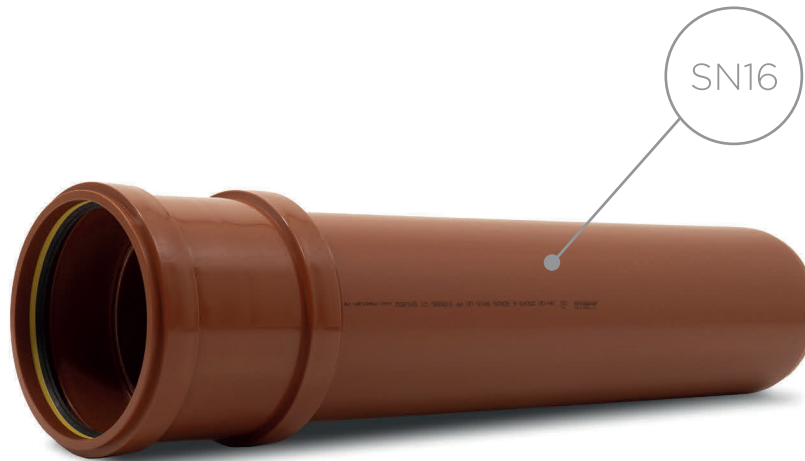

SDR 22 SN 16				
DN/OD	emin A	min	Bmin d	3,min
110	5	40	6	120,3
125	5,7	43	7	137,1
160	7,3	50	9	173,8
200	9,1	58	12	215,6
250	11,4	68	18	272,9
315	14,4	81	20	338,9
400	18,2	98	24	427,1
500	22,8	118	28	533,2

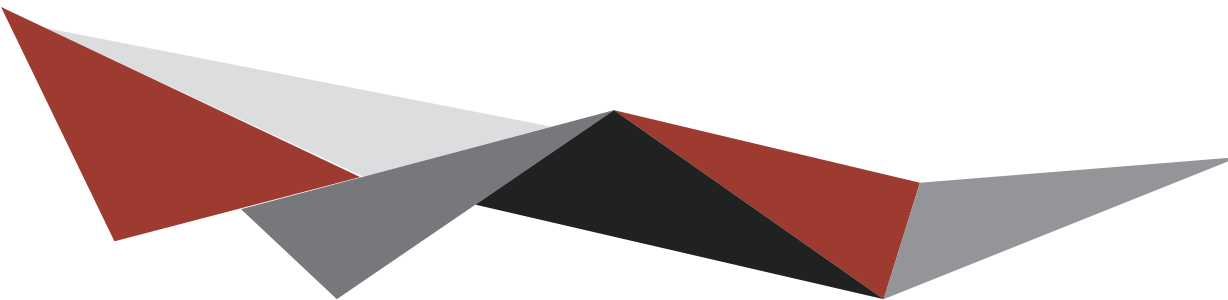

# Class and pipe stiffness

SN 4	S 16	SDR 33
SN 8 S	14	SDR 29
SN 10	S 12,5	SDR 26
SN 12	S 11,8	SDR 24,6
SN 16	S 10,5	SDR 22

Material characteristics	Value	Standard
Density	900 kg/m <sup>3</sup>	ISO 1183
MFR (230°C/2,16 kg)	≤1,5 g/10min	ISO 1183
Internal pressure test (80 C, 4,2 MPa)	➤ 140 h	ISO 1167-1
Internal pressure test (95 C 2 5 MPa)	➤ 1000 h	ISO 1167-2
Rensile Strain at Yield (50mm/min)	6,5%/33MPa	ISO 527-1 ISO 527-2
Charpy Impact Strength (23 C / -20 C)	29 / 2 kJ/m <sup>2</sup>	ISO 179/1eA
Ring stiffness, SN	4, 8, 10, 12, 16	ISO 9969
Chemical resistance	2...12 pH	ISO/TR 10 358
Temperature resistance (short term/longterm)	80/60 C	
Temperature conductivity	0,2 W/mK	DIN 52612
Linear coefficient of stretching	0,14 mm/Km	DIN 52328
Module of elasticity	2000 MPa	ISO 178
Connection technique	Socket and rubber	
Rubber ring	Rubber ring with plastic strengthened in deferent color and with two closing surfaces	



# PP STRONG fittings

---

Within the Peštan production program there is a complete fitting program made in diameters from from Ø110 to Ø315 produced in ring stiffness of SN8 and class S13.3, while fitting Ø400 is produced in stiffness of SN4 and classS16.

The coupling is produced in the class SN16. with 10.5 in all dimensions.





**Rubber rings** are made of EPDM rubber with plastic reinforcement



**PP Strong** fitting marking



**Reinforced ribs** for higher fitting strength

Fittings class according to the 1852 standard

Nazivni prečnik DN/OD	Nazivni spoljašnji prečnik, dn	Minimum wall thickness		
		SN 2 S 20 SDR 41	SN 4 S 16 SDR 33	<b>SN 8 S 13,3 SDR 27,6</b>
110	110	-	3,4	<b>4,0</b>
125	125	-	3,9	<b>4,6</b>
160	160	-	4,9	<b>5,8</b>
200	200	-	6,2	<b>7,3</b>
250	250	6,2	7,7	<b>9,1</b>
315	315	7,7	9,7	<b>11,4</b>
400	400	9,8	12,3	

Vrednosti emin u skladu sa ISO 4065



EN 1852 (SDR 27,6)- SN 8							
mm	DN 110	DN 125	DN 160	DN 200	DN 250	DN 315	DN 400
Dem (mm)	110,0	125,0	160,0	200,0	250,0	315,0	400,0
e min (mm)	4,0	4,6	5,8	7,3	9,1	11,4	14,5
D3 min (mm)	120,3	137,1	173,8	215,6	272,9	338,9	427,1
B min (mm)	6	7	9	12	18	20	24
A min (mm)	40	43	50	58	68	81	98
L1 min (mm)	62	68	82	98	118	144	178

The coupling is produced in the class SN16 with 10.5 in all dimensions

1852 (SDR 22)- SN 16								
mm	DN 110	DN 125	DN 160	DN 200	DN 250	DN 315	DN 400	DN 500
Dem (mm)	110,4	125,4	160,5	200,6	250,9	316,1	401,2	501,5
e min (mm)	4,5	5,2	6,6	8,2	10,3	11,3	16,4	16,4
D3 min (mm)	120,3	137,1	173,8	215,6	272,9	338,9	427,1	533,2
B min (mm)	6	7	9	12	18	20	24	28
A min (mm)	40	43	50	58	68	81	98	118

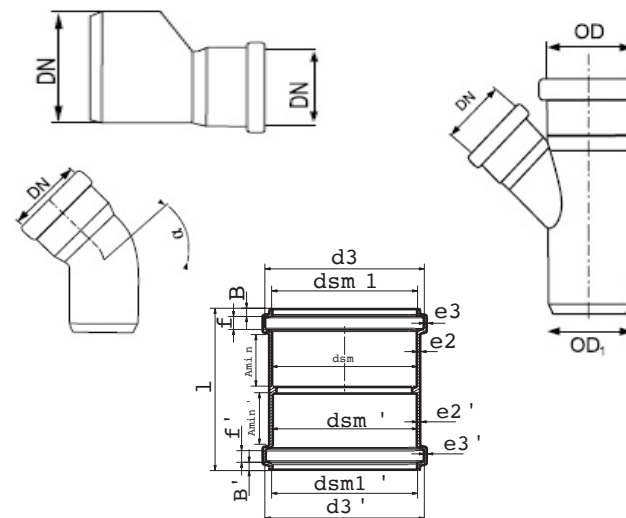

PP STRONG BEND		
DN [mm]	Angle [°]	
	110	15
30		
45		
67,5		
87,5		
125	15	
	30	
	45	
	67,5	
	87,5	
160	15	
	30	
	45	
	67,5	
	87,5	
200	15	
	30	
	45	
	67,5	
	87,5	
250	15	
	30	
	45	
	67,5	
	87,5	
315	15	
	30	
	45	
	67,5	
	87,5	
400	45	
	87,5	

PP STRONG BRANCH		
DN [mm]	Angle [°]	
	110/110	45
87,5		
125/125	45	
	87,5	
160/160	45	
	87,5	
200/160	45	
	87,5	
200/200	45	
	87,5	
250/160	45	
	87,5	
250/200	45	
	87,5	
250/250	45	
	87,5	
315/160	45	
	87,5	
315/200	45	
	87,5	
315/250	45	
	87,5	
315/315	45	
	87,5	
400/160	45	
400/200	45	

PP STRONG SOCKET	
DN [mm]	
110	
125	
160	
200	
250	
315	
400	
500	



PP STRONG REDUCTION	
DN [mm]	
200/160	
250/200	
315/250	

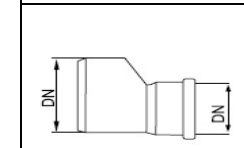

# Packaging of pipes and fittings

---

Peštan PP Strong pipes and fittings are packaged in transport packages (unit and pallet) in a way favorable to customers. The packaging ensures the customer safety during storage and easy handling with the same.

Pipes in lengths of 1m all up to 6m are packed in packages which, depending on the diameter and length, contain a certain number of pieces both in unit packaging and whole packages.



*The look of packed package with 3 frames*

*Note:*

*For exact information on the dimensions of the package and the number of pieces on unit and transport package, contact Peštan on email: [office@pestan.net](mailto:office@pestan.net)*



Standard packages of coupling elements (fittings) are in cardboard packaging in specified dimensions, which represent unit packages.



**Transport and manipulation:**

Peštan PP Strong pipes and all connecting elements should be transported with appropriate transport vehicles. The loading area of the transport vehicle must be solid, flat, without sharp protrusions and without any waste parts (both on the floor and on all sides of the inner part of the transport vehicle). The dimensions of the pallets and packages are such that the loading space of the vehicle is maximally filled.

When it comes to loading pipes outside the transport package, the pipes must rest on a flat surface with their entire length in order not to cause deformation of the pipes. The couplers must therefore be alternately rotated and pulled out for their entire length. This should primarily be taken into account with the pipe of large lengths, because for them improper handling it can come to bending at their ends.

When loading and unloading both pipes and fittings should be handled with care, they should not be thrown, pulled, pushed, especially on concrete and other rough surfaces.

**Note:**

When manipulating and transporting at the temperatures of less than 0°C, be especially careful to avoid striking stresses in order to avoid mechanical damage to pipes and fittings.

**Storage:**

Peštan Strong PP fittings, which are packed in a cardboard packaging, are stored exclusively indoors (preferably, one pallet - one pallet place). If there is no regal warehouse, it is recommended that this type of transport packaging is stored in a closed space on a flat surface and in one level (do not place a pallet on the pallet).

The transport packaging should be stored in a dry, clean and closed environment with temperatures between 10 and 30°C and a relative humidity between 50 and 60%. Packages should be protected from the direct influence of sunlight, moisture and heat. When the pipe warehouse outdoors they should be protected from direct influence of sunlight with UV protective foil or eaves.

Also, when storing, the pipes must not be stored near the heated surfaces and should be kept in mind not to come in contact with fuels, solvents ... Also, when storing pipes under the pipe, lay wooden billets so that the joints at the ends of the pipe do not rely on the surface and therefore deform.

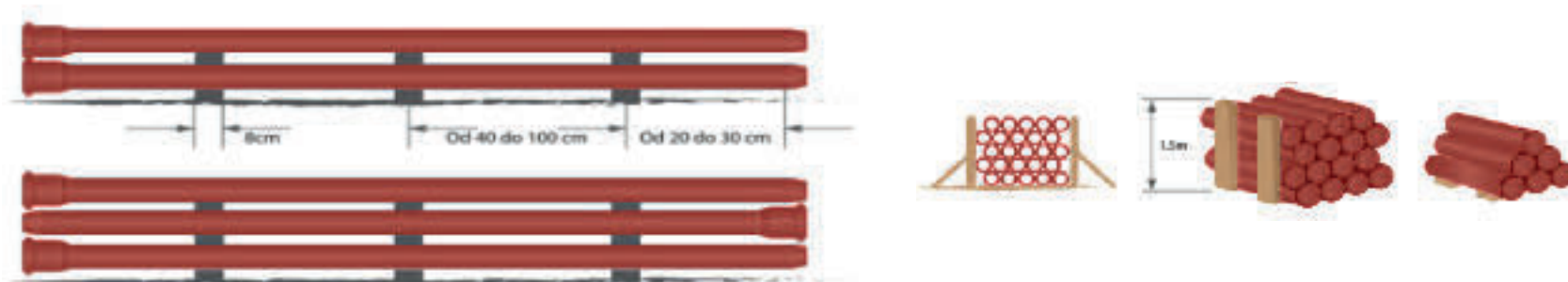

# Installation and connection

Peštan Strong PP pipes and fittings are installed in accordance with EN 1601 Gravity drainage system of street sewers.

If there is a specific regulation within certain countries which deviates from the above mentioned norms, be sure to consult Peštan technical support before installing the system.

## introduction

The first step in the design of sewage systems is geotechnical investigations along the entire route of the pipeline, while the most important condition for achieving a satisfactory pipe installation systems interactions of the pipe and the surrounding soil. The greatest support for embedded pipes gives the soil around the lower half of the pipe in both directions. Therefore, it is very important what kind of soil is done by laying as well as a procedure that is done in the field of soil compaction around the pipe.

## Cutting

Connection of the PP Strong sewage elements are interconnected with rubber sockets for the SN4, SN8, SN10 and SN12 pipes that provide a watertight base of elements, while in the pipe class SN16 pipes connect with other elements via the SN16 class coupling.

All pipes and fittings have a socket coupling in at least one end. Pipes can be cut either with a special pipe section or with a handsaw. When cutting pipe, cutting must be carried out perpendicular to the axis of the tube, the cut end must be clean and skew.

The table can find the necessary fixings in relation to the diameter of the pipe.

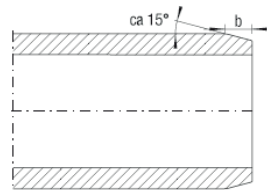

View the required punctation

DN/OD	b [mm]
110	7
125	7
160	9
200	10
250	14
315	17
400	20
500	23

### Connecting pipes and fittings

When connecting pipes and fittings, all steps must be taken to ensure a secure connection to avoid leaking due to further installation and subsequent use.

In order to connect pipes and fittings, it takes a few steps to execute before that:

1. Clean the pipe fitting and straight end of the pipe.
2. After cleaning the pipes and fittings, check the condition of the sealing elements.
3. After cleaning the check of the condition of the sealing elements, it is necessary to lubricate the flat end of the pipe and the rubber fitting. Peštan lubricants are recommended for this purpose. Lubricants based on oil must not be used. Socket and the sealing rubber bands must be dry and clean. They must also be lubricated.

### Laying pipe in a trench

Peštan Strong PP pipes can be placed in a relatively loose ground. When laying the pipes must be taken into account that in places where the socket coupling or the section is deeper so that coupling aligns along its length, and when it does not disturb the drop tube. Illustrated explanation is below.

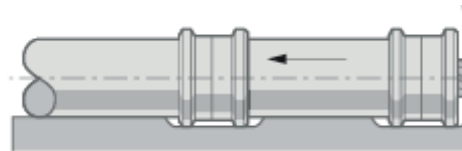

When laying pipes and fittings on steep sections, measures should be taken due to the operation of the longitudinal force. In practice, this is most often achieved by the production of concrete resistor blocks.

### Filling and compacting

The filling (30 cm above the tube's head) is followed in layers. Lightweight and medium compacting devices can be used up to 1 m covering. Heavy machines can only be used afterwards.

The filling material must be compacted in layers of thickness from 10 to 30cm, and the required thickness of the overtemperature is:

- Minimum 15cm for diameter DN > 400
- Minimum 30cm for diameter DN < 400

For these surfaces, a minimum compression of the main overfill of 90% is required according to the modified Procter's Density.

### Installation of flood prevention device - non-return valve

When installing a PP strong pipeline, the designer can foresee the installation of a non-return valve on certain sections. In places where there is the possibility of returning water from the street sewer to the facilities, as well as preventing the entry of rodents and other animals through the pipeline. Non-return valves are equipped with automatic valves for closing the flow of water and are opposite to the intended flow of water.

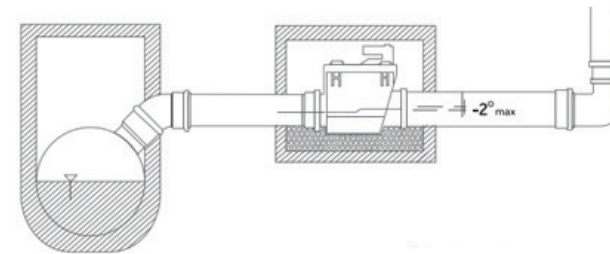

### SAG - Saddle After Grip

SAG - Saddle After Grip is used for subsequent connection to the existing pipeline and in combination with PP Strong pipes gives quick and easy solution. The joint is safe and waterproof, which is provided by the EPDM rubber on the inside of SAG.

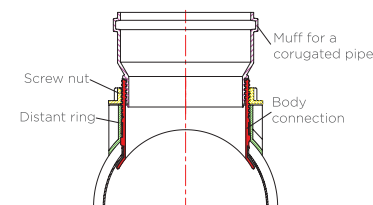

Possibility of making drain manholes of diameter  $\varnothing 315$  and  $\varnothing 400$  of PP Strong pipes.

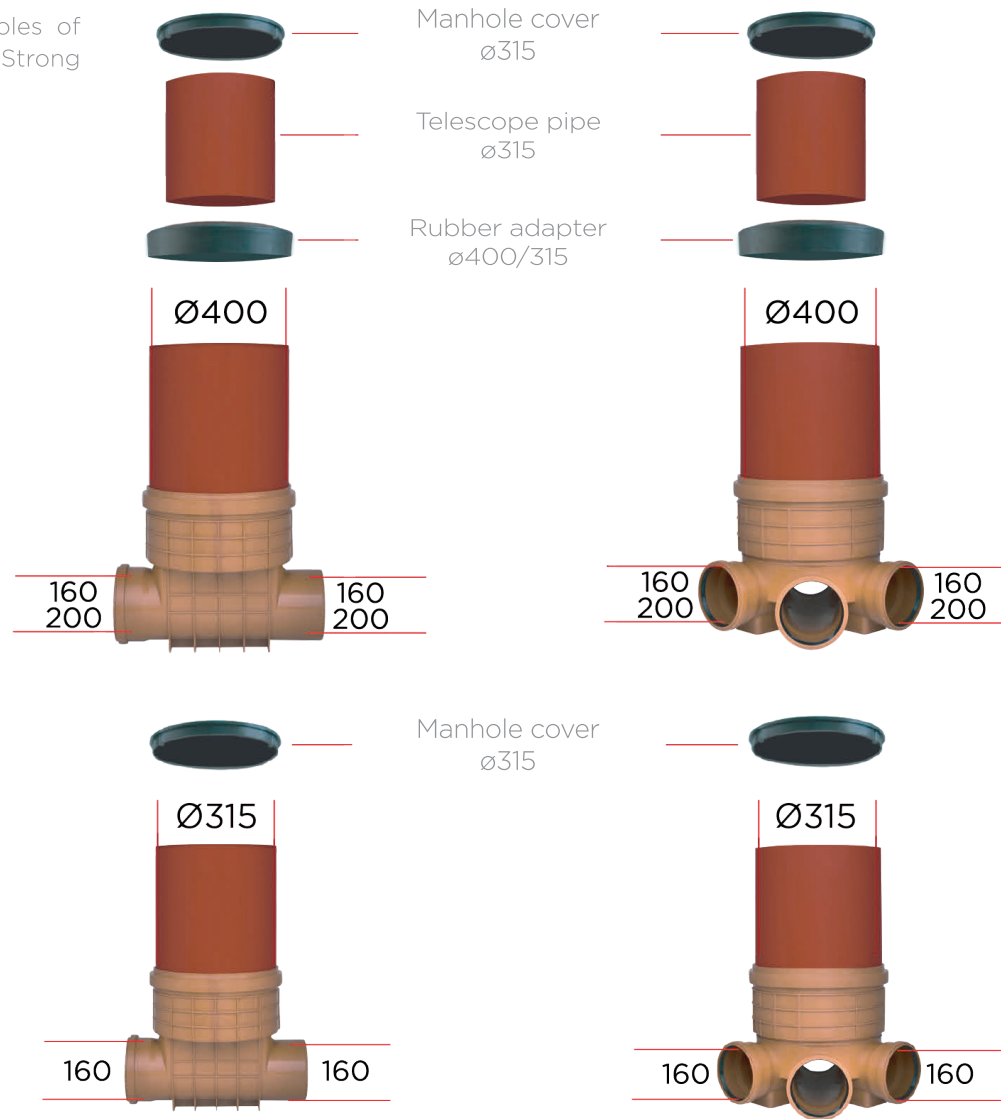

# BREND MANIFESTO

We do not only sell pipes, we combine reliability with quality for the ultimate benefit of our clients.

We do not build short-term client relationships, but long-term and genuine partnerships.

Everything we do, we do with one thing in mind - to create ideas to perfectly match all our client needs and the best way for us to achieve this goal is to constantly educate our clients provide solutions that meet their specific needs and support them throughout the entire process.

Because our success is as big as your trust in us.



+381 034 700 300  
OFFICE@PESTAN.NET

1300 KAPLARA 189  
ARANDJELOVAC  
34300 SERBIA

---

**WWW.PESTAN.NET**