

**12dB (A)**

Sound Insulation  
Level III

TECHICAL CATALOGUE

**S-LINE**

PIPES AND FITTINGS DN 32-250



# CONTENT

GENERAL REMARKS 2	2
ABOUT THE COMPANY	5
1. STANDARDS APPLICABLE TO PEŠTAN HT (PP) PIPES AND FITNG	6
2. BASIC INFORMATION ON PEŠTAN PP PIPES AND FITTING	7
2.1 Marking of pipes	8
2.2 Marking of the fitting	8
2.3 Production program	9
3. PACKAGING, TRANSPORT AND STORAGE	10
3.1 Packaging and pipe fittings	10
3.2 Transport and handling	11
3.3 Storage	12
4. INSTALLATION AND CONNECTION	14
4.1 Types of pipeline	14
4.2 Connecting pipes and fittings	16
4.3 Reliance pipeline	17
4.4 Oslanjanje cevovoda	18
4.5 Penetration of pipes through the ceiling	19
4.6 Installing the pipe in concrete	19
4.7 Installation of the device to prevent flooding in buildings	19
4.8 Measures to reduce noise	20
4.9 Firefighting measures	20
4.10 Testing of the pipeline	21
5. USE OF PIPELINES	22
6. DISPOSAL OF INTERFERENCE	29
7. MAINTENANCE	29
8. REMOVAL AND DISPOSAL	30
9. PROCEDURE IN POSTUSAGE	30
10. LIST OF ABBREVIATIONS	31
11. TABLE OF CHEMICAL RESISTANCE	32
11.1 Introduction	32
11.2 Scope	32
11.3 Definitions and symbols as abbreviations	32
12. CERTIFICATES	41
13. PRODUCTION PROGRAM	43

# GENERAL REMARKS

*Technical catalog is subject to change in certain intervals as a result of the adoption of new products and modifications thereof. For that reason it is necessary to check whether you have the latest version of technical catalog. Date of issue technical catalog is on the cover of a catalog of the latest version it can be downloaded from Site [www.pestan.net](http://www.pestan.net) or request via email [office@pestan.net](mailto:office@pestan.net).*

Quick access to sections provides with the help of pictograms

**Bitne  
informacije**



**Security  
recommendation**



**Legal  
remark**



Before starting the installation of Pestan Silent pipes and fittings for sewers, please read all recommendations related to safety and safety at work with the aim of your safety and safety of people around you. All the while installing system keep these instructions with you. If some of details of this technical catalog are not clear contact us at mail [office@pestan.net](mailto:office@pestan.net)

## **General safety recommendations:**

- Consider all general safety rules for prevention of accident when setting up pipes and fittings
- Provide sufficient light during installation of pipes and fittings
- Keep the work area clean
- Keep away from children, pets and unauthorized persons from tools and place of installation of pipes and fittings

## **The measures when setting up the system:**

- If you have jewelry or other items be sure to remove them before installing.
- Cutting tools should be properly disposed of and toused with great care because they have sharp edges.
- When you shorten the pipes they should be kept safe of the distance between a hand held hose and toolscutting never put your hands near work where the tool cuts.
- When you are doing a service, maintenance or when changing city assembly, always switch off the power to the tool.

## **Protection of fire:**

- Be sure to carefully review the measures for fire protection and building regulations that apply in each special case with special emphasis on:
- Breakthrough through the ceiling, the roof and walls
  - Rooms with stricter requirements with preventive requirements for fire protection (Review national regulations)

## **Personal requirements:**

- Only authorized and trained persons can install the system of Pestan products
- Work with electrical appliances on the components of the tube can be performed only by persons who have been trained and authorized for this purpose

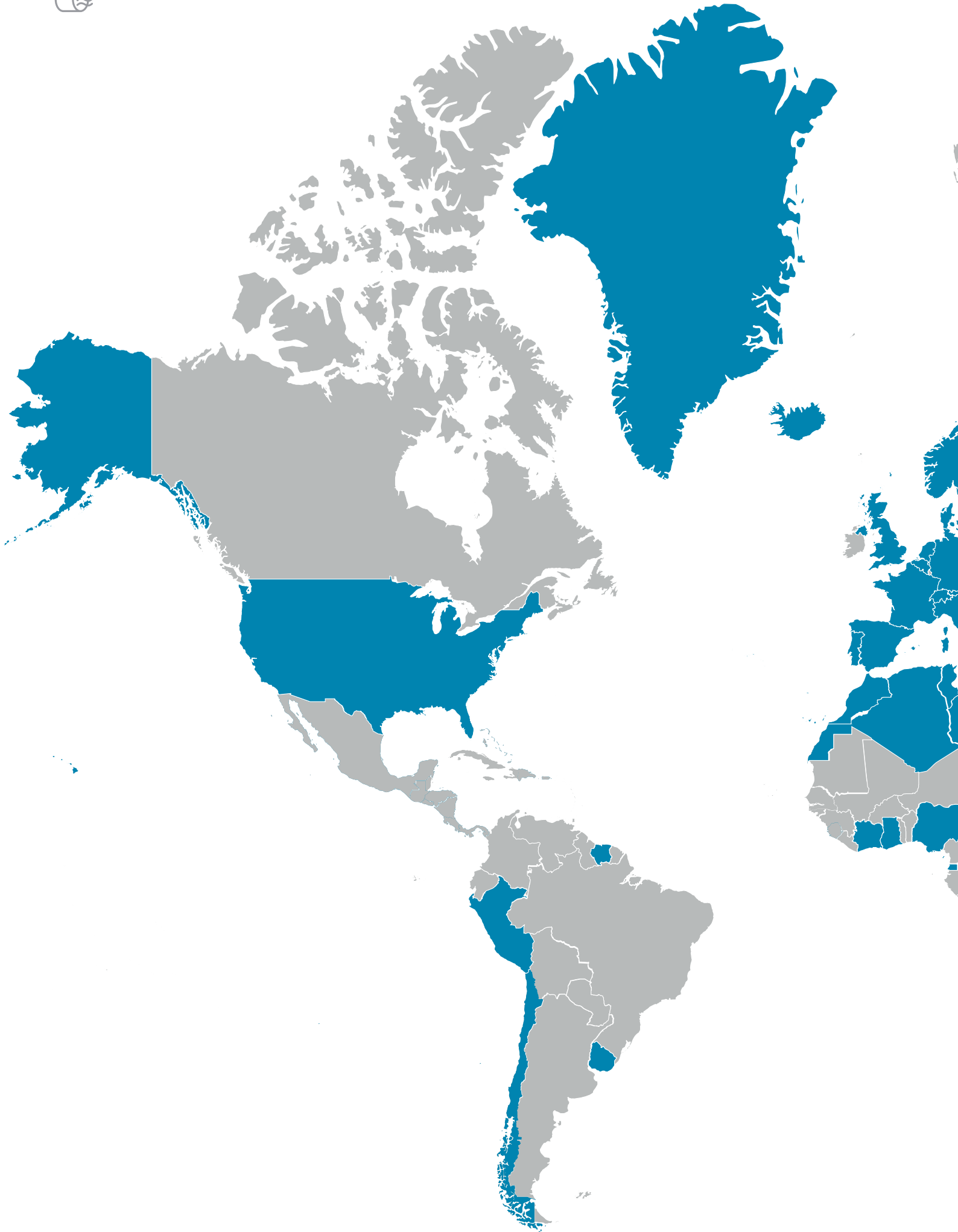

A world map with a light blue background. The map is stylized with white outlines for continents and countries. Several regions are highlighted in a darker blue color, including parts of Europe, the Middle East, North Africa, and South America. A white rounded rectangle is centered over the map, containing the text 'ABOUT US'.

# ABOUT US

Private company Peštan is a leader in the Balkan in the production of plastic pipes and fittings for water, sewer and gas. The company was established in 1989 and has been producing water pipes made of polyethylene. Over time, introduced with new materials (polypropylene and PVC) and expanded production program. Today the offer can be found over 5000 products ranging from pipes and fittings and PVC profiles, through luxury and modern drains, to tape for irrigation. Production facilities are located in 70 km south of Arandjelovac from Belgrade, and foreign missions in countries in the region: Bosnia and Herzegovina, Romania, Croatia and the Ukraine and UAE.

The company is present in the market of Europe, Russia, Middle East, North Africa, Latin America and the United States. Export-oriented and sales implemented in over 60 countries of the world!

PEŠTAN the organization and operations of the Company established and certified to the requirements of the Integrated System management

- The quality management ISO 9001 (since 2004)
- Environmental management, ISO 14001 (from 2010 g)
- Management of Occupational Health and Safety OHSAS 18001 (since 2010.g)

PEŠTAN products certified by an appropriate normative regulations with the most eminent certification Body: DVGW, MPA, SABS, BULGARKONTROLA, blanket, IGH, BJW, VUSAPL, ICC, SKZ, EMI ... In order to meet the needs of as many customers, the company is constantly innovating and improving personnel and equipment. Since 2009, the company introduced the SAP ERP modules MM, SD, PP, CO Fi and a since 2012. year they expanded functionality and WMS. Introduction WCM and WMS system has increased efficiency, contributed to deployment costs and professional maintenance. Since 2015, SAP has been implemented in the management module Quality Management (QM).

Employees of Peštan which has over 1000, the joint efforts of the company justify the slogan:



# 1 STANDARDS

## STANDARDS APPLICABLE

### ON PEŠTAN silent PIPES AND FITNG

SRPS EN 1451-1:2008 Sistemi cevododa od plastičnih masa za odvođenje zaprljanih i otpadnih voda (niske i visoke temperature) unutar građevinskih konstrukcija - Polipropilen (PP) - Deo 1: Specifikacije za cevi, fitinge i sistem

EN 1451-1:1998 Plastics piping systems for soil and waste discharge (low and high temperature) within the building structure - Polypropylene (PP) - Part 1: Specifications for pipes, fittings and the system

SRPS EN ISO 3126:2009 Sistemi cevododa od plastičnih masa - Komponente od plastičnih masa - Određivanje dimenzija

EN ISO 3126:2005 Plastics piping systems - Plastics components - Determination of dimensions

SRPS EN 744:2008 Sistemi cevododa i kanala od plastičnih masa - Termoplastične cevi - Metoda ispitivanja otpornosti na spoljne udare obodnom metodom

EN 744:1995 Plastics piping and ducting systems - Thermoplastics pipes - Test method for resistance to external blows by the round-the-clock method

SRPS EN ISO 2505:2013 Termoplastične cevi — Dimenzionalna stabilnost pri zagrevanju — Metoda ispitivanja i parametri

EN ISO 2505:2005 Thermoplastics pipes - Longitudinal reversion - Test method and parameters

SRPS EN ISO 1133-1:2013 Plastične mase – Određivanje masenog protoka rastopa (MFR) i zapreminskog protoka rastopa (MVR) termoplasta – Deo 1: Standardna metoda

ISO 1133-1:2011 Plastics - Determination of the melt mass-flow rate (MFR) and melt volume-flow rate (MVR) of thermoplastics - Part 1: Standard method

SRPS EN ISO 580:2009 Sistemi cevododa i kanala od plastičnih masa - Injekciono presovani termoplastični fitinzi - Metode za vizuelnu procenu efekata zagrevanja

ISO 580:2005 Plastics piping and ducting systems - Injection-moulded thermoplastics fittings - Methods for visually assessing the effects of heating

SRPS EN 1053:2008 Sistemi cevododa od plastičnih masa - Termoplastični nepritisni sistemi cevododa - Metoda ispitivanja vodonepropusnosti

EN 1053:1995 Plastics piping systems - Thermoplastics piping systems for non-pressure applications - Test method for watertightness

SRPS EN 681-1:2007 Elastomerne zaptivke - Zahtevi za materijale zaptivki spojeva na cevododima namenjenim za dovod i odvod vode - Deo 1: Guma

EN 681-1:1996/A3:2005 Elastomeric seals - Material requirements for pipe joint seals used in water and drainage applications - Part 1: Vulcanized rubber

SRPS EN 12056-1:2011 Gravitacioni sistemi za odvođenje otpadne vode u objektima - Deo 1: Opšti zahtevi i zahtevi za performanse

EN 12056-1:2000 Gravity drainage systems inside buildings - Part 1: General and performance requirements

SRPS EN 12056-2:2011 Gravitacioni sistemi za odvođenje otpadne vode u objektima - Deo 2: Sanitarna cevna mreža, plan i proračun

EN 12056-2:2000 Gravity drainage systems inside buildings - Part 2: Sanitary pipework, layout and calculation

SRPS EN 12056-3:2011 Gravitacioni sistemi za odvođenje otpadne vode u objektima - Deo 3: Odvodnjavanje krova, plan i proračun

EN 12056-3:2000 Gravity drainage systems inside buildings - Part 3: Roof drainage, layout and calculation

SRPS EN 12056-4:2011 Gravitacioni sistemi za odvođenje otpadne vode u objektima - Deo 4: Pumpne stanice za otpadnu vodu - Plan i proračun

EN 12056-4:2000 Gravity drainage systems inside buildings - Part 4: Wastewater lifting plants - Layout and calculation

SRPS EN 12056-5:2011 Gravitacioni sistemi za odvodnjavanje otpadne vode u objektima – Deo 5: Ugradnja i ispitivanje, uputstva za upravljanje, održavanje i upotreba

EN 12056-4:2000 Gravity drainage systems inside buildings - Part 5: Installation and testing, instructions for operation, maintenance and use

SRPS EN 1411:2008 Sistemi cevododa i kanali od plastičnih masa - Termoplastične cevi - Određivanje otpornosti na spoljne udare stepenastom metodom

EN 1411:1996 Plastics piping and ducting systems - Thermoplastics pipes - Determination of resistance to external blows by the staircase method

SRPS EN 14366:2008 Laboratorijska merenja buke od instalacija za otpadne vode

EN 14366:2004 Laboratory measurement of noise from waste water installations

# 2 INFORMATION

Basic information about  
S LINE pipes and fittings

The program of S LINE pipes and fittings from the company Peštan is produced from PP-C (polypropylene copolymers) by latest technology extrusion three-layer tubes per the requirements of European Standard 1451. The latest technology of three-layer extrusion of pipes and modified mineral materials additives, have raised the system of draining contaminated and waste water within the building structure to a higher level. Recyclable without loss of mechanical properties of polypropylene make ecologically suitable material.

Pipes and fittings from S LINE Peštan production programs are intended for soil and waste discharge (low and high temperature) within the building structure. S LINE system is universal and it can be used for drainage of contaminated water, for one-floor houses to large multiple floor buildings.

Installation and manipulation of elements of the pipeline is very simple and it is described in the forthcoming chapters of this technical catalogue. Connecting pipes are made via the connecting elements, the fitting, while the water tightness is provided with rubber sealing rings. Inner layer of polypropylene sewage pipes has a very low roughness, resulting in good hydraulic characteristics, high resistance to abrasion, as well as to the retention of sediments and bacterial cultures for the inner wall of the pipe. For easier inspection of pipeline, inner layer of pipe is made in white colour.

S LINE pipes and fitting are resistant to corrosion and their lifespan is over 50 years.

**i** Pipes and fittings possess exceptional thermal stability and they are resistant to:

- **short thermal loads of hot water of up to 95 ° C (30 seconds / day)**
- **continuously up to 60 ° C (5hrs / day = 87,600 hrs / 50 years)**

In terms of chemical resistance HT (PP) LOW NOISE pipes are resistant to: salt water, alcohol, acids, alkalis, sulphates, aggressive gas and all kinds of detergents. They are suitable for drainage of aggressive chemical waste, pH value of 2 (for very acid waste water) to 12 (for a very base wastewater). HT (PP) LOW NOISE program is sensitive to waste water containing a high percentage of gasoline (petrol), benzene or acetone. For a detailed chemical

resistance pipeline look at table of chemical resistance, which is an integral part of this technical catalogue. Connection of pipes and fittings are 100% resistant to leakage up to pressure of 0.5bar (5m water pillar). The pipes are not intended for outdoor use due long-term volatility during UV radiation. Also pipes are not intended for installation in the ground. It is not advisable to perform installation of pipelines on temperatures below 5 ° C. Polypropylene has excellent sound and thermal insulating properties (far better than eg. steel). In terms of fire protection, HT (PP) LOW NOISE pipes program belongs to flammability class B2 of DIN 4102, they belong to a group of normally flammable materials.

Peštan S LINE production program pipe includes:

- S LINE pipe diameter 32,40,50,75,90,110,125 and 160 with one socket
- S LINE pipe diameter 32,40,50,75,90,110,125 and 160 with double socket

Peštan S LINE pipes are consisted of three layers, where each layer contributes to the desired characteristics of the product. Illustration of the layers is shown in the picture below.

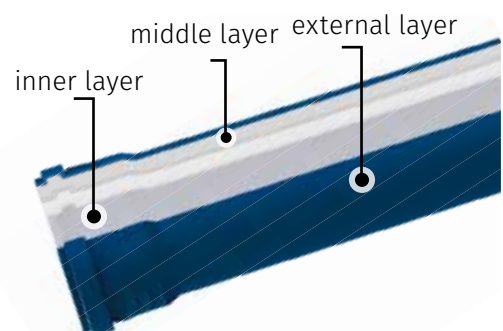

**Inner layer:** Made of polypropylene copolymer, smooth white inner surface. It prevents the buildup of sludge and reduces abrasion on the pipes. It allows easy inspection of the pipeline as it is white. It is resistant to high temperatures and chemicals.

**Middle layer:** Made of polypropylene copolymer and strengthened mineral filler, gives to pipes strength and flexibility.

**External layer:** Made of polypropylene copolymer, blue. Provides better impact resistance to the pipes, and greater safety when handling and installing products.



Material	PP-H (polypropylene copolymer)
Pipe structure	Three-layer composite pipe PPC-PPM-PPC
Density	pipes (Ø32-Ø160) - 1.3 g/cm <sup>3</sup> fitting - 1.4 g/cm <sup>3</sup>
Hot water resistance	short term up to 95°C long term up to 60°C
Linear expansion coefficient	0.05 mm/m°C
Chemical resistance	pH 2- pH 12
E - modulus	2400-3100 MPa
Joining method	Push-fit sockets with inserted rubber ring - resistant to leakage up to pressure of 0.5bar
Application category	BD (instalation in buildings and in building construction)
Fire classification	B2 - normal inflamability
Sound insulation level	12 dB(A) sound insulation Level III

### Basic characteristics:

- Made of a light material with excellent mechanical properties,
- Simple and easy transport and handling,
- Quick and cheap assembling, merging with the end of the pipe muffs
- They are resistant to corrosion in alkaline, acidic or corrosive environments,
- Good electric insulator,
- Resistant to mechanical influences,
- servicelife longer than 50 years,
- practically no costs of pipeline maintenance,
- O-rings are made of EPDM rubber after (EN 681).

## 2.1 Marking pipes

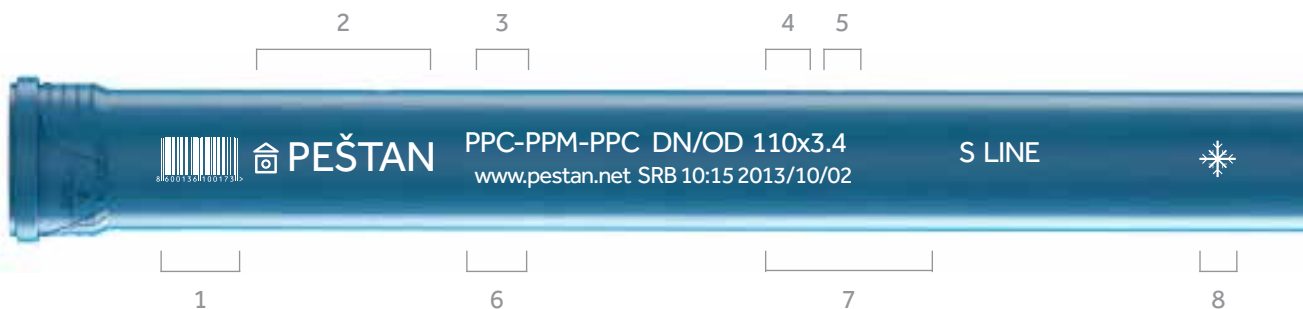

1. Bar kod, 2. Peštan logo, 3. Material, 4.Diameter, 5. Wall thickness, 6. Dimensions according to EN 1451, 7. Date and time of production, 8.Snowflake (installation at low temperatures)

EN 1451 s16								
	DN 32	DN 40	DN50	DN75	DN90	DN110	DN125	DN160
Dem (mm)	32	40	50	75	90	110	125	160
e(mm) min	1.8	1.8	1.8	2.3	2.8	3.7	3.9	4.9
d3(mm) min	38.6	49.6	59.6	84.5	99.5	120.5	137.5	174.3
B(mm) min	5	5	5	5	5,0	6	6	7
A(mm) min	24	26	28	33	33	34,0	36	38
L(mm)	250, 500, 100, 1500, 2000, 2500, 3000, 3500 i 4000							

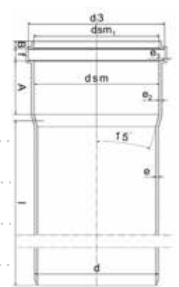





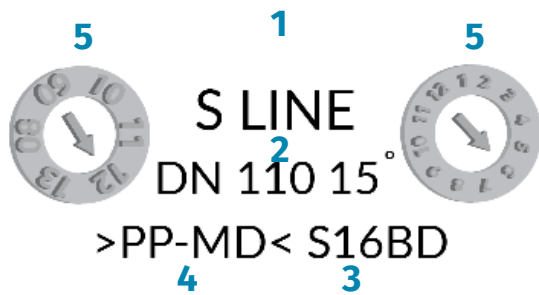

## 2.2 Marking of fitting:

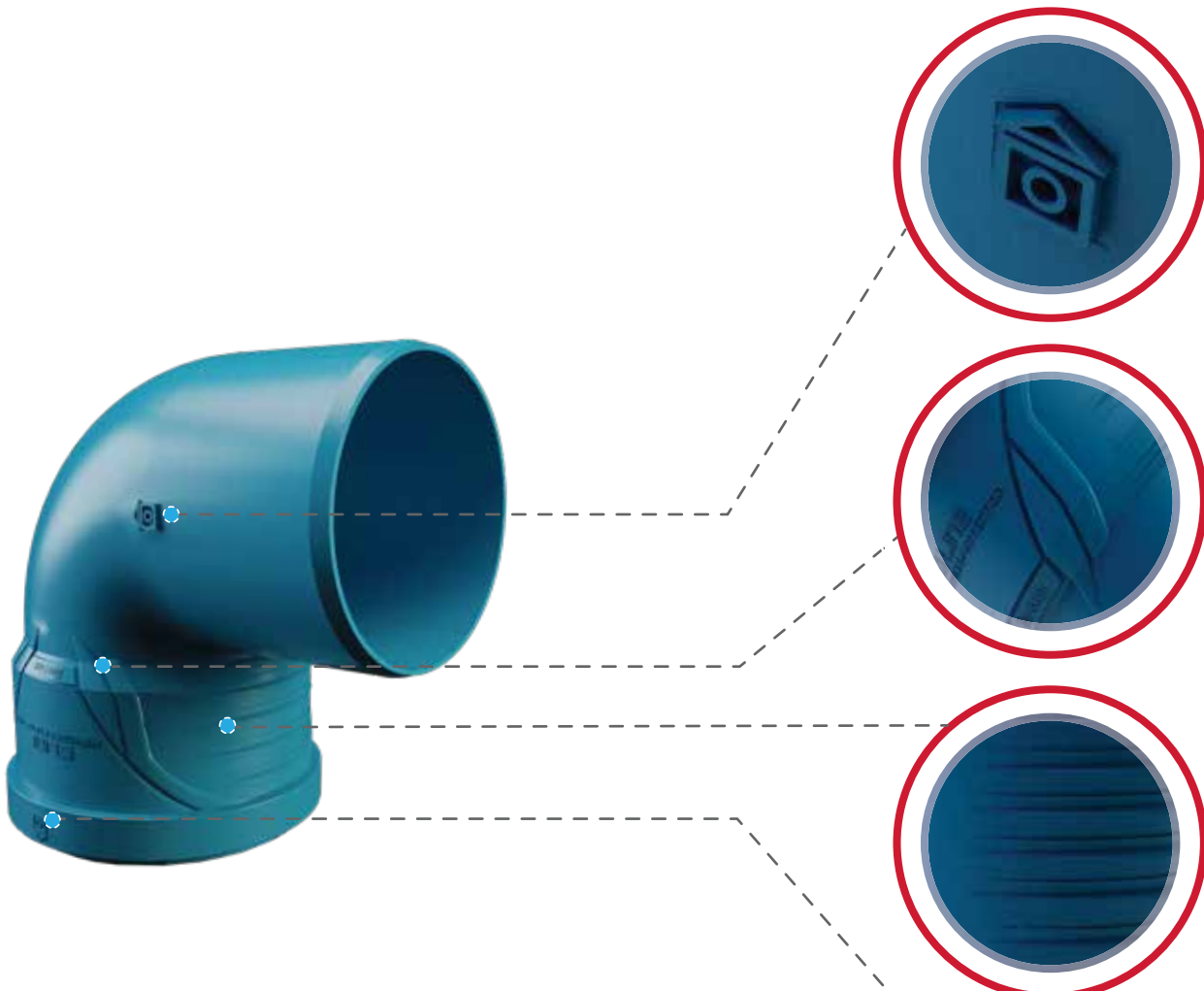

On each fitting is a label with a bar code. For more details, please see a detailed list of products in S LINE production program.

1. Logo
2. Nominal diameter and degree of angle
3. Class of fitting
4. Identification of material
5. Date



-  Peštan logo "House" at the bottom of the fitting, is used as marker for the depth of insertion fitting in socket of the pipe or other fitting.
-  The new improved design of the socket.
-  5 ribs, which are the reinforcing and contribute to thickening of the wall in this section and additional noise attenuation.
-  MARKER for determining the angle of rotation of the fitting.



## 2.3 Product range

Within Peštan S LINE production program ,you can find further fittings:

- Bends 15 °, 30 °, 45 °, 67.5 ° and 87.5 ° of Ø32 diameter to Ø160
- Single and double branches of 45 °, 67.5 ° and 87.5 ° form diameter Ø32 to Ø160
- Double sockets, sleeve sockets, reducers, inspections etc ...



BEND 110\_67.5°



BEND 110\_45°



BEND 110\_30°



BEND 110\_15°



HTB BEND 87.5°



BRANCH 110\_50\_45°



BEND 110\_110\_87.5°



BRANCH110\_110\_87.5°



BRANCH 110\_50\_45°



INSPECTION 110



SLEEVE SOCKET 110



REDUCTION 110\_125



DOUBLE SOCKET

## Peštan S LINE arched T branch

### Noise isolation

Hydraulically optimized Peštan S LINE arched branch in combination with three layer pipes provides higher coefficient of flow and less noise in the sewer pipe. Peštan S LINE system together with Peštan S LINE arched branch is perfect for vertical lines and fast multi-level connections which are optimized for noise.

### The higher coefficient of flow

Hydraulically optimized geometry of jointing elements of Peštan S LINE system together Peštan S LINE arched branch allows economical dimensioning. Smaller dimensions are cheaper and have greater load carrying capacity.

### Dimensions of Peštan S LINE band branch

- 90/90/87.5°
- 110/90/87.5°
- 110/110/87.5°





AVAILABLE  
PROFILES

EASY CAMERA  
INSPECTION

WHITE  
ANTIBACTERIAL  
LAYER

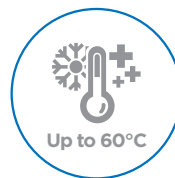
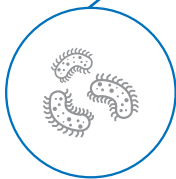
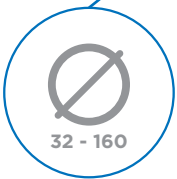

TEMPERATURE  
RESISTANCE

COMBUSTIBILITY

SOUND  
ISOLATION

# 3 PACKING

PACKING,  
TRANSPORT AND STORAGE

## 3.1 Packaging of pipes and fittings

Peštan S LINE pipes and fittings are packed in transport packages (unit and pallet) in a manner favorable to customers. The way of packaging ensures safety to a customer when they do storage and easy handling of the same.

### Packaging of pipes are

Standard packages of e S LINE pipes are in pallets and in packages. Pipes of all diameters lengths from 0.25 to 0.50 meters are packed into cardboard boxes, which in a certain number, packed like this and packed on a pallet represent the transport package. To form the transport package as a basis used EURO pallets dimensions 800 x 1200 mm



*The appearance of the packaging unit (box)*



*Appearance transport of packaging (pallets)*

Pipes in lengths from 1 to 4 meters final is packed in packages which in itself, depending on the diameter and length, contain a number of pieces in the unit package and the whole package. Each package contains a number of unit packages packed with a certain number of wooden beams are extremely transport package and ready for further distribution to the customer.



*The appearance of the packaging unit (connection)*



*Appearance transport package (package)*

### Packaging fittings

Standard packaging coupling elements (fittings) are in a carton box dimensions, representing the packaging unit, in that consists of a number of transport package. Transport packages are formed at EURO pallets in dimensions of 800 x 1200 mm and a height a maximum of 1400 mm.

*Note: For accurate information on the dimensions of the package, number of pieces the unit \_ transport packages*

*Contact Peštan - [office@pestan.net](mailto:office@pestan.net)*



### 3.2 Transport and manipulation

Pestan S LINE pipes and joint elements are transported by suitable vehicles. Loading space of the vehicle must be clear, without any residuals, flat and without sharp lumps (on floor and on the sides of the inner loading part of the vehicle).

Dimensions of pallets and packages are made so the space can be used to the maximum.

When we talk about loading of the transport packages (both pipes and joints) in card board boxes packages are designed so that in the cargo space of height of 2.9m can be placed 2 packages one on top of another.



When loading transport packages of pipes that are sent in packages, depending on the diameter of the pipe, packages are packed by height in two or more levels. Pipes of diameter 75 up to 160 are packed in 2 levels (height of loading space must be at least 2.9m). Pipes of diameter 32 up to 50 are packed in transport vehicle in 4 levels (loading space height must be at least 2.9m).



When the pipes are loaded out of the transport package (separately), pipe has to rely on the flat surface by its whole length so it doesn't deform. For this reason joints have to be pulled out alternately and they need to be pulled out for whole the length of a joint. This should be minded especially with longer pipes because they could get bent on their ends due to the wrong manipulation.

During the loading and discharge pipes and joints they should be handled with care, they should not be tossed, pulled, and pushed over concrete and other rough surfaces.

All kinds of bendings and hits need to be prevented, especially in very low outer temperatures (below zero).

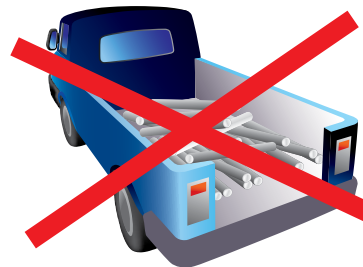
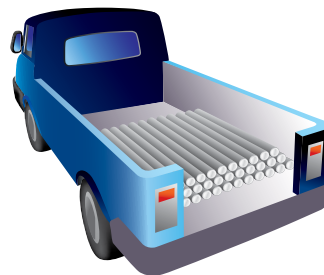
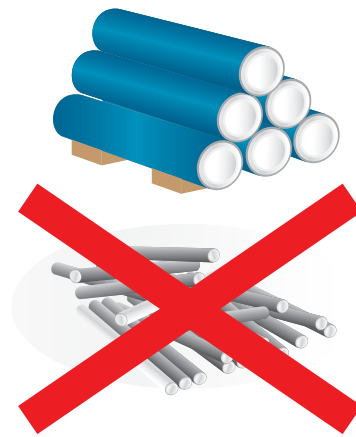

### 3.3 Storage

Peřtan S LINE pipes and fittings packed in cardboard packings are specifically stored in closed space (Shelf warehouses, one pallet – one pallet space).



If there is not a shelf warehouse, recommendation is that transport packings as these are stored in closed space and in one level (do not put pallet on top of another).

When there is no transportation packing but the goods arrived to customer in unit packs, they should be stored on pallets that are dry and clean. Boxes can be piled up one on another. Boxes mustn't be packed out of pallet or to be backed without a base that can hold them.

For storage of transport packaging of low noise pipes and fittings, warehouses need to meet certain conditions.

#### Recommendation for storage:

- Transport packaging should be stored in dry, clean, indoors, where the temperature is between 10 and 30 ° C and a relative humidity between 50 and 60%.
- They should be protected from direct sunlight, moisture and heat and also need to be protected from the high temperature fluctuations as this may lead to occurrence of condensation and loss of functional properties of cardboard boxes.

Peřtan low noise pipes length from 1 to 4 meters can be stored in closed and in the open area. When pipes are stored in the open, that area should be protected from direct influence of sunlight by protective UV stable foil or canopy. It is recommended that these and transportation packaging are stored in an enclosed space, or space that is shaded.

No matter where are stored, whether indoors or outdoors, the packages should not be stacked in more than one level (from  $\varnothing 75$  to diameter  $\varnothing 160$ ), and not more than two levels of pipes diameters of  $\varnothing 32$  to diameter  $\varnothing 50$ .



Although withstanding high temperatures it is not recommended long-term storage of pipes near a heat source. In addition to this it is strictly required to ensure that the pipe during storage does not

come into contact with materials damaging for polypropylene (eg. motor fuel, solutions, wood preservatives).

In the case of bulk pipes (or single pieces packages) attention should be paid to the following:

- pipes should be stored on a flat surface
- pipes should be placed on the wooden beams so the sockets of the pipe would not touch the surface and get deformed.
- pipes should not be dropped, dragged and pushed on uneven surfaces during stacking.
- pay attention to the way of stacking pipes (alternately rotate pipes so the sockets on the ends are free and therefore do not allow their deformation).
- ensure that packed pipes are secured from the sides.
- height of stacked pipes must not exceed a height of 1.5 meter
- pipes are to be stored indoors if there are conditions, if not pipes are stored in a shaded area or cover with UV stable protective film.

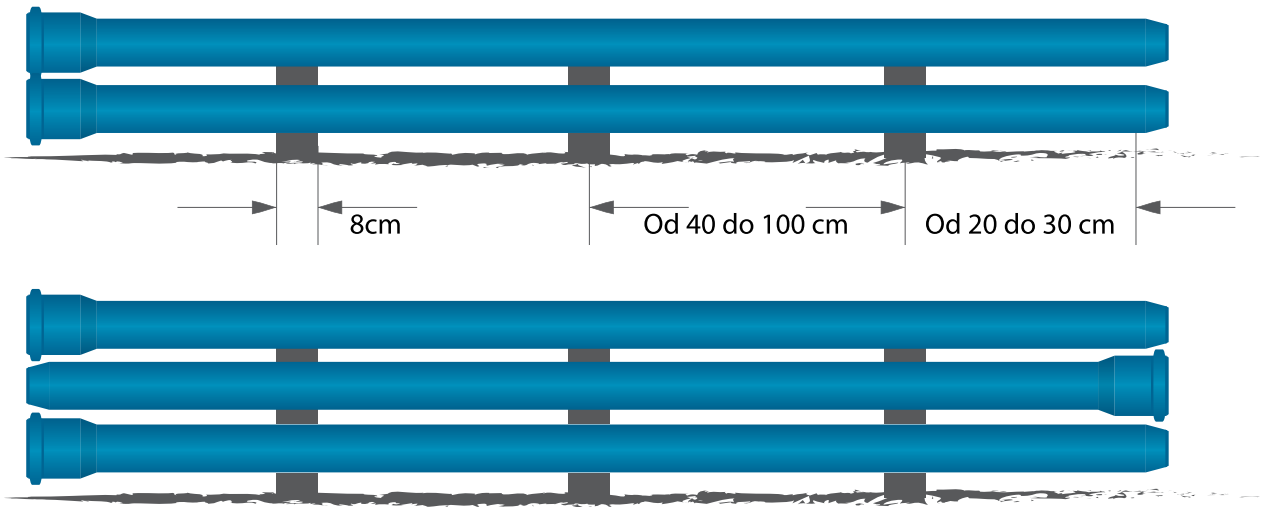

Wooden beams for shimming the pipes should not be narrower than 8 cm and thickness should not be thinner than 5 cm.

Axial distance between the beams depending on the pipe diameters and lengths varying from 400 to 1000 mm, while the overhang tube depend also on the diameter and length tubes also varies from 200 to 500 mm

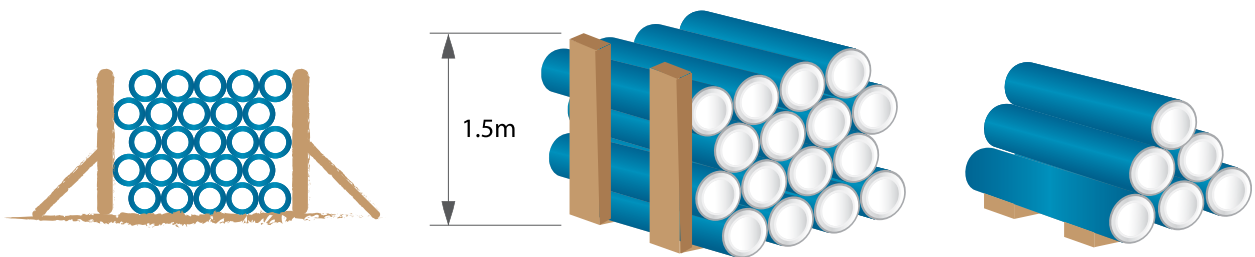



# 4 INSTALLATION

## INSTALLATION AND CONNECTION



Peštan S LINE pipes and fittings are installed in accordance with EN 12056 Gravity drainage systems inside buildings.



If there is a specific regulation within certain countries, which deviates from the norms mentioned, be sure to consult Peštan before installing.

### 4.1 Types of pipelines

To properly comprehend the connection and installation of interior installations for drainage of used water is necessary to explain the types of pipelines, which are part of a system for drainage of water use. The main classification of pipelines is as follows:

#### Connecting line from building to the street

This connection line is a line that leads from the building to terminal on a street circuit. It should be as short as possible and straighter.

#### Connecting line for the places where water is flowing

Connecting line is a pipeline to connect the pouring places (VC cup, bidet, sink, ...). Diameter of pipeline defines a number and type of the pouring places to join him. Connecting cables are mainly installed in grooves, in the walls and floors and closed with mortar or sleeve. The lines of this type can be installed in specially designated channels and can be closed by prefabricated elements, allowing easier access to the pipeline system when changing. Connecting lines also can be hung under the plate, that means for the ceiling of the room, which is located below, via clamps.

There is another way of installing the connecting piping, which is mounting in cavity walls (plaster sandwich walls) and hanging by clips for constructive elements of sandwich walls. Connecting lines must not be longer than 3 m and must have a fall of minimum 3%. Connecting seats with the

casting pipeline is realized via a siphon to prevent the return of odours from the sewage network. Connecting lines should be as short as possible and straighter.

#### The vertical line (“vertical”)

The vertical line is placed vertically (so it got its name) and its purpose is to connect the first type of connecting lines with a second type of connection line. Pestan recommends the use of non-return valves at the connection places. Lines of this type are usually placed inside the walls and closed with mortar or placed in channels, relying on clamps. Placing pipes in the trench allows easier access to the pipeline for maintenance. In the case of plastic piping connections between the vertical line and the connection line is realized through two elbow of 45°. In buildings with more than three floors, cascade is installed to vertical pipe in order to reduce water consumption. Cascade is performed so as to draw the line elbow angle of 90° in the length of 250 mm, than it comes back in the vertical direction by elbow at an angle of 90°. Before elbow, reducer is being installed and after restoring water into vertical direction and by reducing piece returns to its original diameter. In this way, excessive force of water is avoided which would occur at the connecting point of the vertical and the connection line.

The vertical line should have a ventilation hole at its highest point. Pestan can offer venting device, which helps the unpleasant smells to go out through the hole that is outside. Ventilation of vertical line can be: primary and secondary.

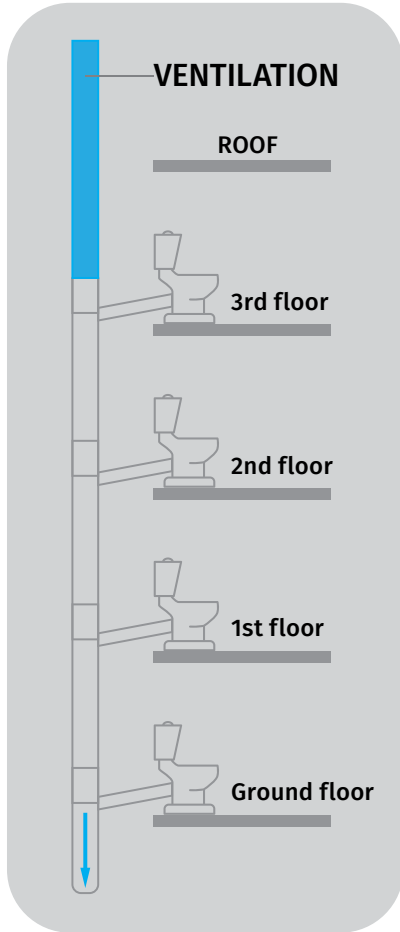

Showing vertically with primary ventilation

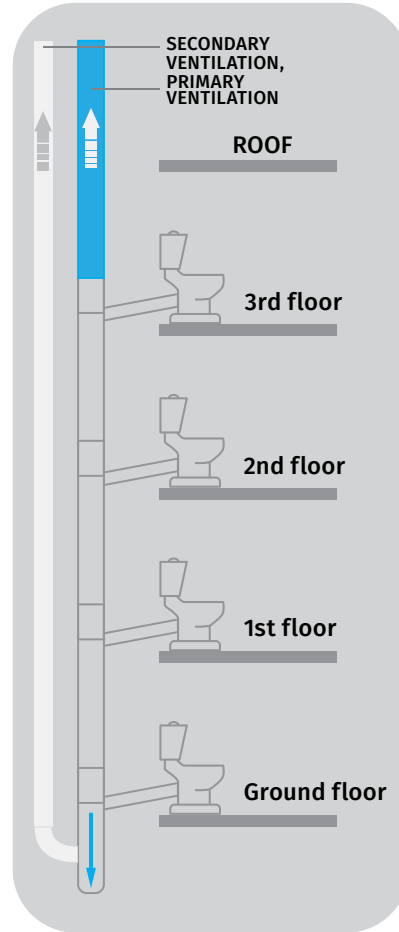

Showing vertically with secondary ventilation

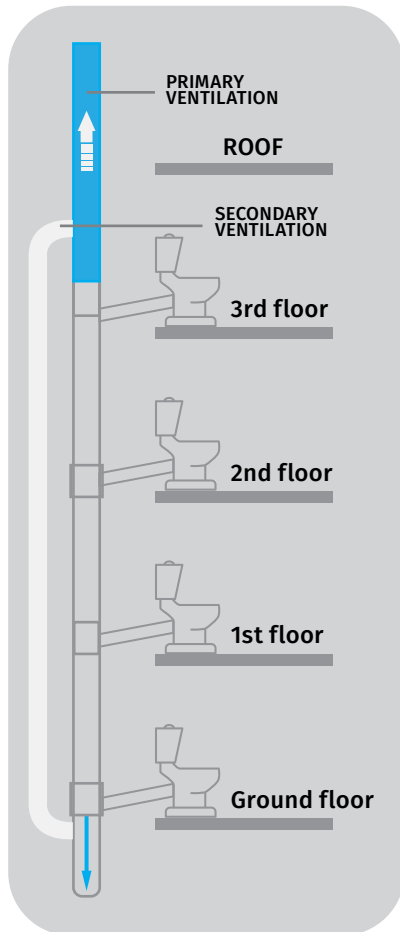

Showing vertically with secondary ventilation

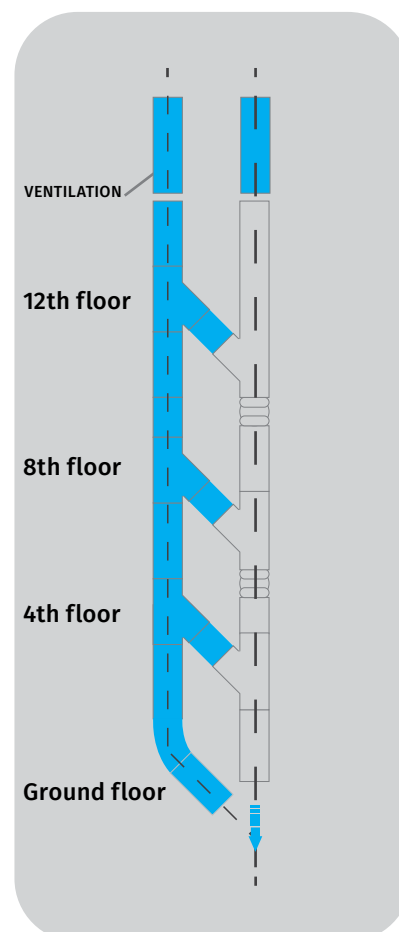

Ventilation at large buildings

## 4.2 Pipes connecting

Elements of S LINE internal sewerage are connected by sockets and rubbers, which enables waterproof elements connection. Gluing pipes is not recommended. All pipes and fittings have at least one socket on the end. Peštan has also the pipes with 2 sockets on offer. Pipes without sockets can be connected by double sockets and sleeve sockets. Pipes can be cut by using a special blade for pipe or hand saw blades with fine teeth, as shown on the picture below.

 Gluing pipes with conventional adhesives cannot be and must not be applied!



**i**

Fitting should not be shortened!

Cutting pipes has to be done perpendicularly to pipe axis. The cut end of the pipe must be cleaned and skew. Skew of end of the pipe that was cut is achieved by fine sandpaper or a fine rasp. There are special tools for cutting, which during the cutting make a fine shape of the end of pipe. The table below shows the dimensions of the slope of pipe end.

Use all safety precautions!

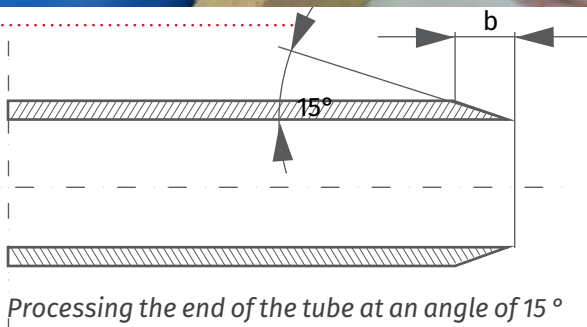
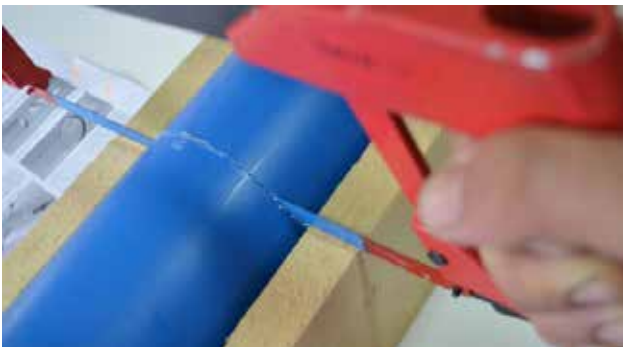

DN	Bevels length							
	32	40	50	75	90	110	125	160
b(mm)	3,5	3,5	3,5	3,5	4,0	4,5	5,0	6,0

*Display of the required length of the taper of the diameter of the pipe*

After preparation of cut pipe or connecting fabric pieces without cutting, it is required to do next:

1. Clean a socket and flat part of a pipe. Cleaning should be done by dry or damp cloth.



2. After cleaning of pipe, condition of sealing elements should be inspected.



3. After cleaning and checking a condition of sealing elements, the flat end of the pipe should be lubricated. Peštan's lubricants are recommended for this purpose. Lubricants based on oil, cannot be used. Socket and rubber seal should be dry and clean and they are not coated with a lubricant.





4. Once the lubricant is applied to the flat end of the tube, the same until the end inserted into the socket. Mark the depth of entry the pipe socket and pull the hose approximately 10 mm (1 cm). On this way pipe leaves room for "work" in thermal dilatation. If it works with pipes the maximum length of 2000mm (2 m) with muffs, pull-out hose 1 cm is quite enough. In the case of the use of longer pieces of pipe (for example 4 m) must be carried out lire, or dilation accept changing direction, in this case the level of the ends of the tube fully inserted into the socket.



Preview of properly inserted pipe in to socket pipe.

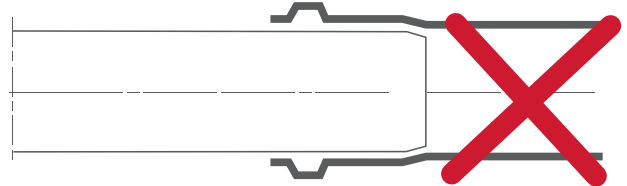
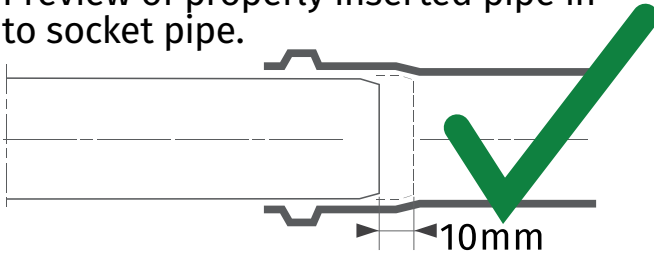

### 4.3 Connecting pipes and fittings

A difference of connecting two pipes, which must take into account the depth of insertion of a tube in the other, when it comes to connecting pipes and fittings or two fittings each other, it is important to emphasize the role of the new design of low noise fittings.

The new design is intended stop-marker (logo Pešťan-house) for the depth of insertion of the fitting into the pipe or fittings in the fitting. In this way, it is not necessary measuring the depth of insertion or extraction, the fitting of the sleeve tube or other fitting, because the tab does not allow for a greater depth of insertion of the prescribed.

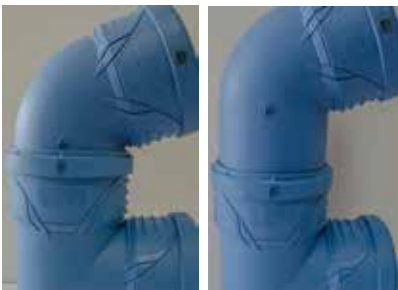

In the new design of the fitting is necessary to point

out the markers for adjusting the angle of rotation of the fitting with respect to the next fitting in a row (for the rotation markers placed every 45 °).



Also when installing the pipeline, there is a cutting pipes which results have the appearance of the remains of the tubes that not bearing sleeves (pipe is smooth on both sides). On the picture below shows how Connecting of pipeline looks like with sliding couplings and pipes without sleeve. In this case, without pipe sleeve that is installed between the two connectors witch must have minimum length of twice the nominal diameter ... For example, if the diameter of 160 mm, the minimum length pipes without sleeve must be 320mm

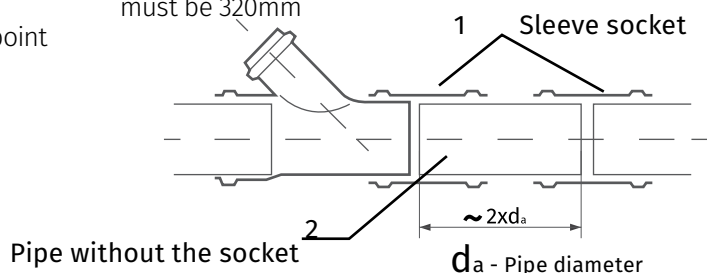

Also, while installing pipeline, where there are remains of pipes without socket, it should be noticed that length of the remains shouldn't be more than 3m. For such an installation, it is required to ensure enough quantity of sleeve sockets and double sockets, and certain quantity of clamps with profiled rubber bands.

On picture below, a difference in installation of remains of pipes without socket, with double and sleeve socket. More about pipeline reliance during installation in the next section.

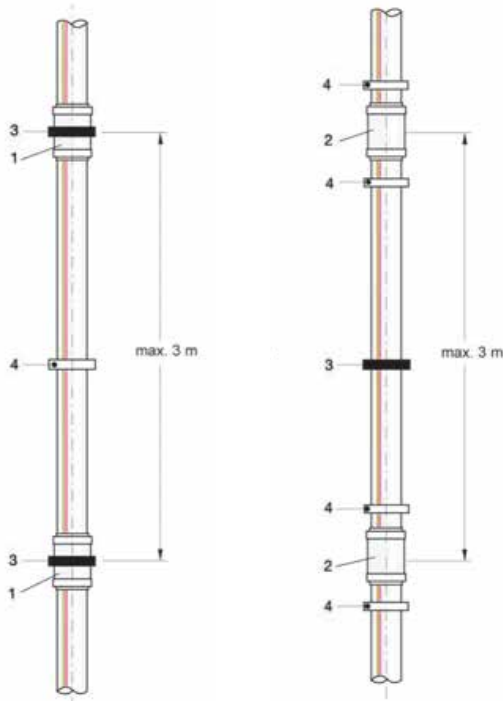

1. Double socket  
2. Sleeve socket

3. Fixing point (support)  
4. Slip on point (support)

## 4.4 Pipelines reliance

Pipelines reliance may be continuous or reliance in points. In case of installation of pipelines in the wall of the building, it is called continuous reliance, and pipeline reliance through the clamp is called pipelines in points.

### Continuous pipeline reliance

This kind of reliance provides support for the pipeline along its entire length. These are pipelines placed inside the masonry walls and floor structures and panels. Penetrations through walls and grooves for the pipeline, which are closed by mortar must ensure installation of pipelines without voltage on pipeline and potential-free condition of the pipeline during the settlement of the building. Built-in pipeline, by the mode of installation should be protected from mechanical influences.

Full pipe elements must be placed in the breach. Connection between the pipes shouldn't be in the breach. In the case of polypropylene pipes for internal canalization, closing pipes by mortar can be done immediately after the assembly and installation of insulation, however it is not recommended to close the pipeline before checking water resistance, because in this way the immediate inspection of pipelines is disabled. In case that the sewer pipe is near the water pipe, which transports warm water, both should be thermal isolated in accordance with applicable standards. It's required with horizontal lines to support them throughout the length when installing in the floor, and at the same time the ability to compensate for temperature dilatation must be provided.

### Pipeline reliance in points

When pipelines reliance in points, the pipelines not supported throughout, and therefore terms of reliance of pipes, should be defined.

There are two types of point supports by way of reliance:

- Fixed (FT)
- moving (KT)

Fixed supports prevent the moving in all directions, and must be located below all sockets of the pipeline, ie in the case of pieces of pipes with both flat end, fixed bearing is installed on a double socket or sleeve socket. It should be noted that the fixed supports don't allow elongation of pipes, therefore it is necessary to position the supports in the way which enables that between two fixed support there is an element for compensation of the elongation of pipe (socket, if installed as described above or compensating element if the dilatation can not accept by space left in the socket).

Recommended spacing of supports		
DN	for horizontal pipeline (m)	for vertical pipeline (m)
32	0,50	1,2
40	0,50	1,2
50	0,50	1,5
75	0,80	2,0
90	0,95	2,0
110	1,10	2,0
125	1,25	2,0
160	1,60	2,0

Display of recommended spacing of supports for piping according to pipe diameter, distances are related to supports in general, while the preference for fixed or sliding support is performed according to the aforementioned criteria.

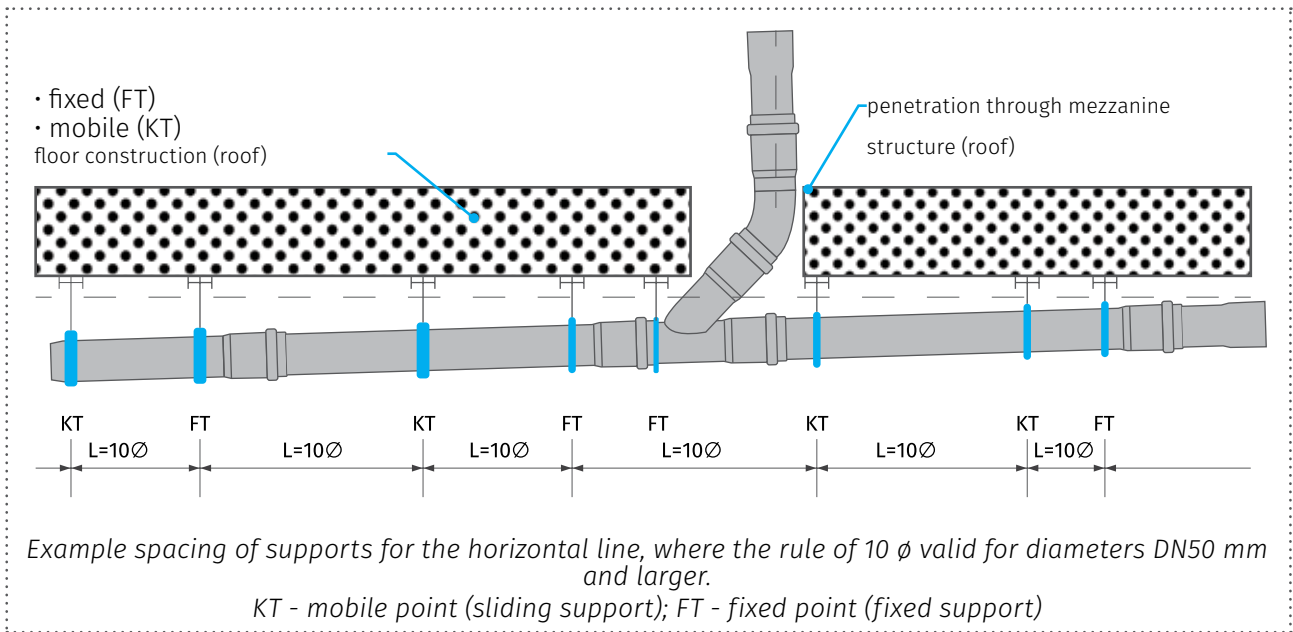

#### 4.5 Penetration of pipes through the ceiling

Pipes through the mid floor and the ceiling must be soundproof and waterproof. The use of a KGF pieces for a breakthrough pipes through the ceiling is to ensure water resistance compound. When penetration through the mid floor Structures smaller diameters, waterproofing can be provided with mineral fibers, PP insulating foam or bituminous insulation. In the case of the need for providing a spread of fires there are special measures that can be taken about that. It can be set in the pipe factory sleeves, these sleeves that are placed on the side of a mezzanine structure are in higher risk of fire.

#### 4.6 Installing the pipe in concrete

S LINE Pešťan pipes can be installed in concrete without any problem, if one takes into consideration longitudinal dilation. When watering pipes are in the concrete they should be well ensured that there would be no relocation pipeline during the installation of the concrete. It should also provide a pipe joint with a protective tape to prevent leakage of cement to sealing elements.

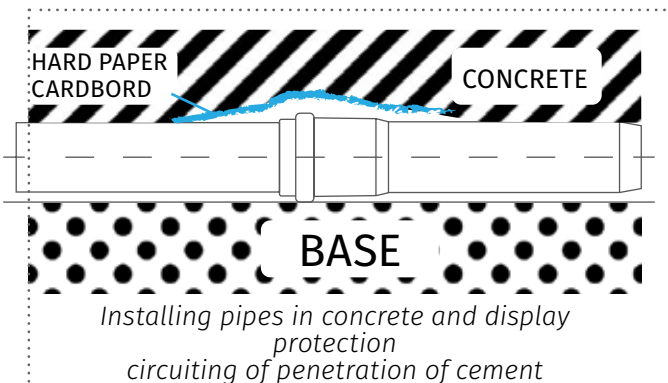

#### 4.7 Installing the device flood prevention in buildings

##### - Check valves

Non-return valves are installed in pipelines where there is the possibility of returning water from the street sewage systems in buildings due to increases in water sewage system and to prevent the entry of rodents and other animals through sewerpipe. As stated earlier the use of return valves are in places where the vertical lines are connected to the connection line it is recommended by Pešťan.



Non return valves are equipped with an automatic flaps for closing the water flow, and an opposite direction in relation to the intended flow of water.

The basic postulate of installation

- Non-return valves are installed in less manholes easily accessible for cleaning the device.
- When you do the cleaning do not use items with sharp edges.
- Maximum allowable downfall when placing the check valve is 2%.

The following figure shows the scheme installation of non-return valve.

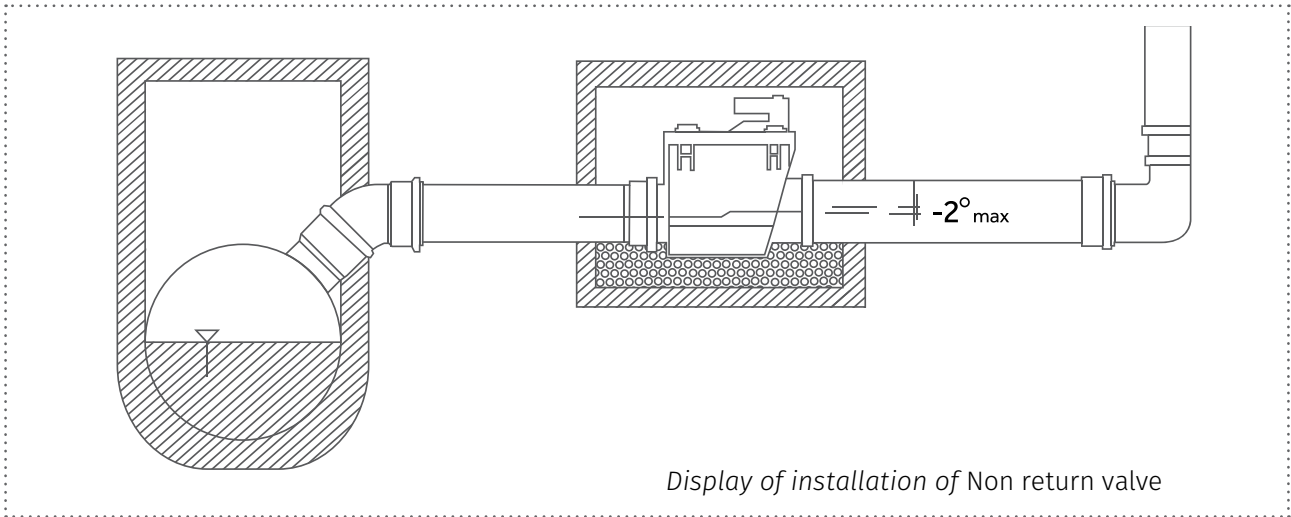

### 4.8 Noise reduction measures

According to norm DIN 4109 the noise made by pipelines built in soundproof rooms mustn't surpass 35dB. From fore mentioned reason, the pipes shouldn't be seenly placed in those rooms. Pipes are placed in canals designed on purpose for installation, if surface weight of the wall is greater than 220kg/m<sup>2</sup>. Further noise reduction is achieved if clamps with rubber implants are used and by using plastic anchors for fixing the clamps to the wall. By using Pestan S LINE pipe systems the supreme results in noise cancelation are achieved. More about it will be written in following chapter.

### 4.9 Fire safety measures



Pestan S LINE pipes and fittings during fire hazards are completely in accordance with standard DIN 1402, and are placed in B2 category (class of normal inflammability). Preventive anti fire protection that prevents fumes and smoke from breaking trough the places where pipe is passing trough is an obligation for every tall building. According to latest european standards , during the placement of the pipes between the walls and floors of the building it is obligatory to use special clamps which prevents spreading fire between the rooms of an object. Always use proven and tested suppliers.

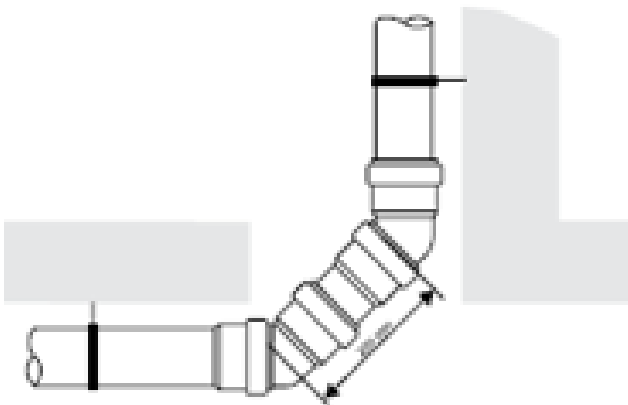

*The transition from a vertical to a horizontal line (For zones of low allowable noise)*

In cases of the fire hazard, plastic pipes affected by high temperatures are being softened and deformed. At the same time at temperatures of 150°C special anti fire laminate is extending and is increasing it's volume up to 10 times. During it's expansion inside of the metallic part of the clamp, laminate is pressing the pipe around which the clamp is placed, pressure up to 10bar. In just a few minute, as the consequence of the pressure, anti fire laminate completely presses the plastic pipes, closing the breaching point of the pipe in the wall or the floor. This prevents fire or smoke to spread inside of an object or between the rooms.

During the installation of anti fire clamps on the breach spot of the pipe on the floor it should be know that clamps can be placed during the constructions or afterwards.



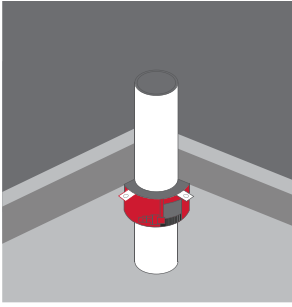

Installation of fire collars to basic ceiling (after construction)

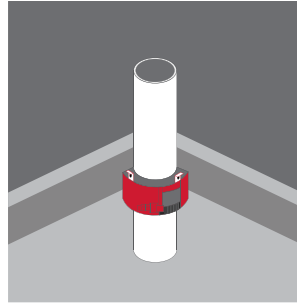

Installation of fire collars for basic ceiling (during construction)

During the installation of fireproof clamps on breaching points in walls it is necessary to place 2 clamps on both sides of the wall.

When pipe is breaching the wall by the angle it is necessary to mention that in this case clamp is being placed only in case of floor pipe breach.

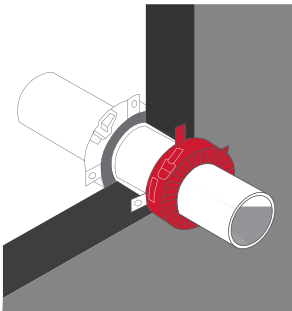

Installation of fire Clamp on the walls

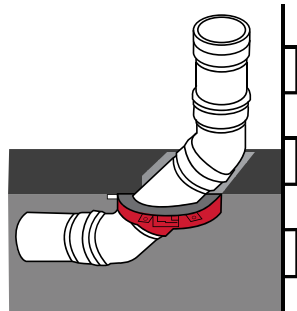

Mounting of angle fire collars (only to basic ceiling)

## 4.10 Testing the pipeline



Testing the inner sewage pipeline can be divided into 3 parts:

- Technical inspection
- Waterproofness test
- Gas impermeability test

Pipeline must not be covered before the tests are done, all joints must be visible and clean. All openings must be temporarily shut during the test of waterproofness. Water during the test should be clean. Overpressure during this test should be between 0.3bar - 0.5bar. Test lasts for 1 hour. Criteria for passing the test is not to lose more than 0.5l/h on every 10m<sup>2</sup> of inner surface of pipeline.

Pipeline is tested after the montage of inlets and segments testing. Segments are isolated with revision openings. It should be kept in mind that the highest pressure is present in the lowest segment point of the pipeline and in that spot maximal allowed pressure is 0.5bar.

Obligation of every constructor is to make the memo of testing the pipeline and under those conditions guaranty granted by Pestan is valid.



Respect the rules of local regulations of fire prevention and fire extinguishment in objects.



# 5 NOISE REDUCTION

USE OF THE PIPELINE

Pestan S LINE pipes and fitting are installed in accordance with EN 12056 gravitational drainage system inside of buildings. If a special regulation exists in other country and is different than norm it is necessary to consult Pestan about it before the installation. In every area of edification sound isolation is every day more and more important. The pipe lines that transport fluids are one of the most frequent noise sources in buildings.

Both types of noise can be reduced to a minimum in different ways. Airborne noise is reduced by producing the pipes and fittings in special manner of special materials with special mineral additives or by optimizing the usage of fittings on spots where pipelines change direction. On direction changing spots it is recommended to use the elbows 45° and a pipe 25mm instead of an elbow 87.5°, so the level of noise made by flow and direction change can be reduced to maximum.

## 5.1 Noise reduction measures

There are 2 types of noise differed by what brings it:

- Airborne noise
- Structure-borne noise

Airborne noise is transmitted by air, and it comes from within the pipeline, it is the consequence of the fluid flow inside of the pipes. Pestan systems with its special design are limiting this noise level by keeping it inside the pipe.

Structure-borne noise is transmitted over the object walls. Vibrations occur during the fluid flow trough the pipe and fittings over the clamp and onto the building walls making irritating noise. With using the right clamps with profiled rubber of known producers and with proper installation of Pestan system of low noise pipes and fittings, this type of noise is reduced to a minimum.

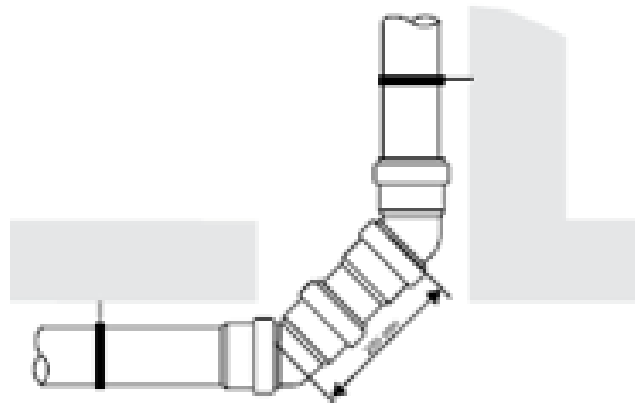

*The transition from a vertical to a horizontal line  
(za zone niske dovoljene buke)*

Structure-borne noise is decreased by properly installing the pipeline with quality clamps with profiled rubber on (fixed points) also by optimized tightening of clamps (sliding spots).

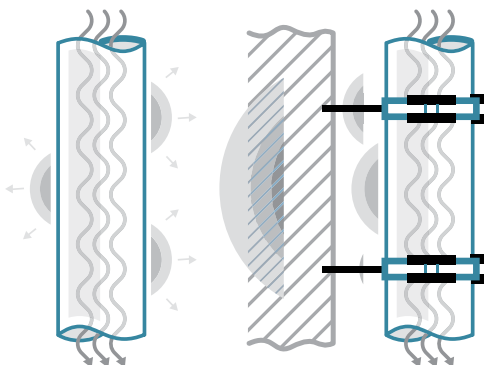

*The noise that is transmitted  
air (Airborn noise)*

*The noise that is transmitted  
through the walls of buildings  
(Structure-borne noise)*

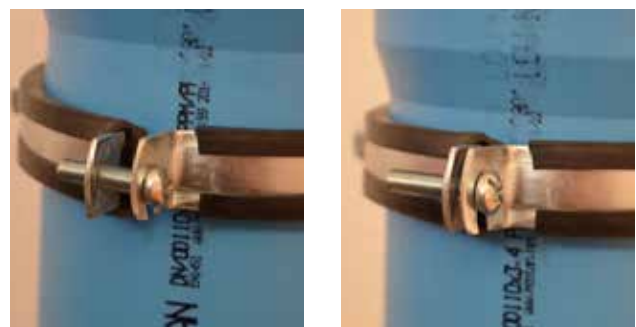

*Display of loose and tight clamps on pipes*



## 5.2 Lab testing of sound isolation

To certify efficiency of sound isolation, system of pipes and fittings for house sewage Pestan S LINE system is sent for testing to German Fraunhofer Institute for construction physics. Testings are made by EN 14366 norm (Laboratory measurement of noise from waste water installations) and by DIN 4109 (Sound insulation in buildings – Requirements and verifications), according to which the noise level must not surpass 35dB (A) in apartment building that require greater sound isolation. Water installations) and by DIN 4109 (Sound insulation in buildings – Requirements and verifications)

according to which the noise level must not surpass 35dB (A) in apartment building that require greater sound isolation. Testing is made under the flow 0.5/ 1.0 / 2.0 and 4.0 L/sec.

Testings are made by EN 14366 norm (Laboratory measurement of noise from waste

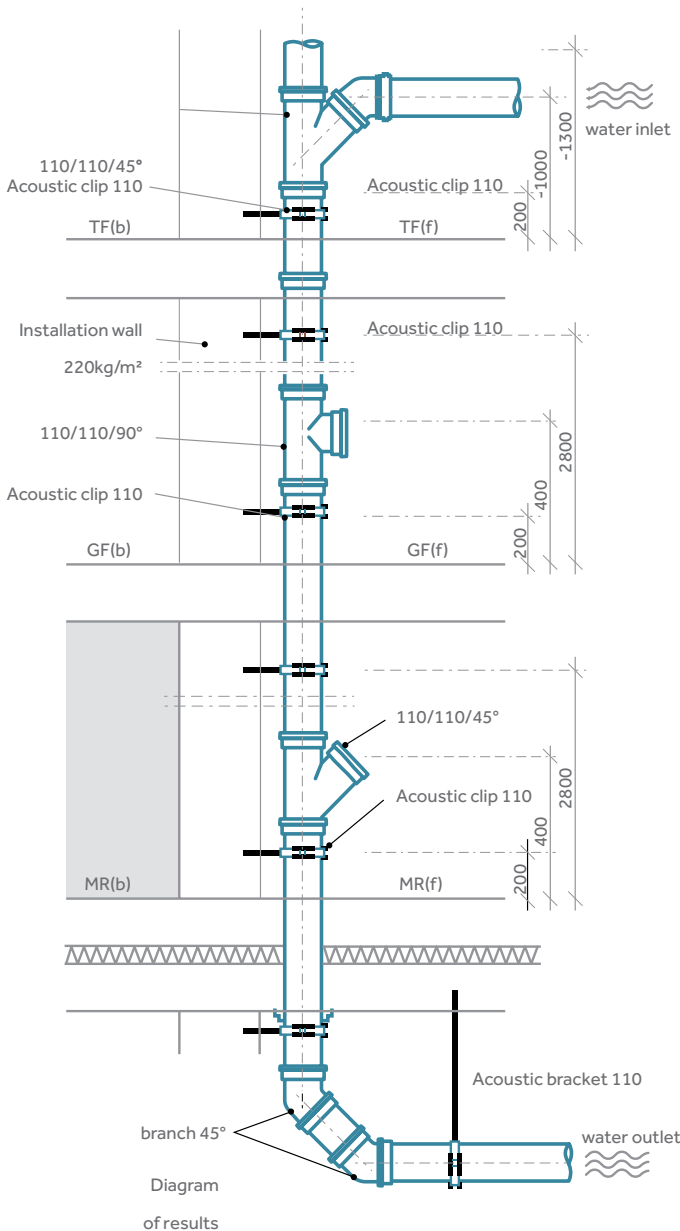

Display of system Installation in the Fraunhofer Institute

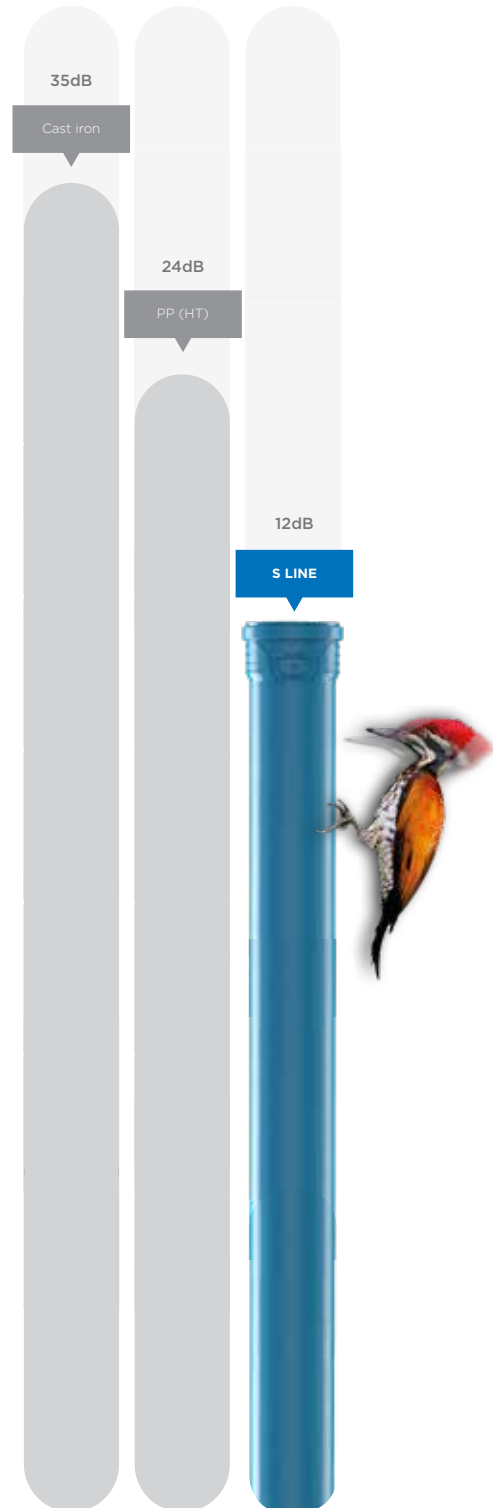

Efficiency confirmation of elimination of fore mentioned problems of noise inside of pipe systems Pestan emitted by Fraunhofer, where by measuring was established that level of noise generated inside of Pestan pipe system is 12dB (under the fluid flow 2l/s(DN110). S LINE pipes are wanted in buildings where noise level reduction is required on minimum, such as hospitals, schools, libraries, dormitories etc.)

Results achieved during the test with Pestan S LINE pipe system (behind the wall of 220kg/m<sup>2</sup> and minimal thickness of 115mm plus mortar), a with different flows they gave the following diagram.

According to studies, Peštan S LINE pipes and related fittings can be classified into LEVEL III of sound insulation with results of 12dB(A)\*, obtained in the tests\*\*.

Izvor: LSC,A [dB(A)] Fraunhofer test report P-BA 213/2016e

The measurement results with commercial pipe clamp, "BISMAT 2000", behind a wall in the basement.

Ln – noise level dB(A)

Q – flow rate L/sec

\* - the maximum allowed noise level by DIN 4109\*\*

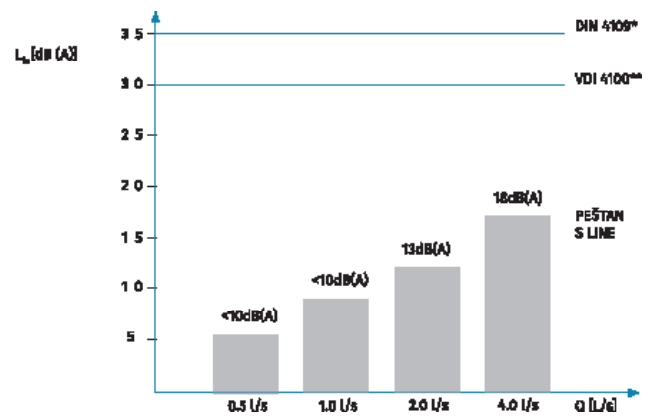
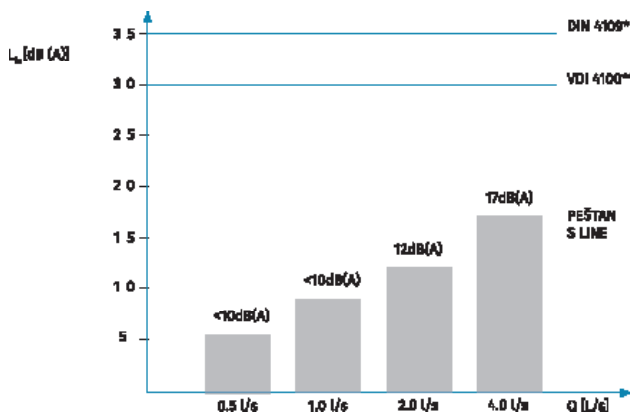



## 5.3 Level of sound isolation and classification

According to VDI 4100 there are 3 degrees in sound isolation, depending on the purpose of object in which the pipes are installed:

\*Level 1 DIN 4109 corresponds to 30dB (A)

\*Level 2 corresponds to 25dB (A)

\*Level 3 corresponds to 20 dB (A)

VDI level of sound isolation and class

\*Level 1 - Family house

\*Level 2 - apartment building and offices

\*Level 3 - Hotels, hospitals, libraries, living complexes



Family house  
**Level I of sound isolation**



Apartment building and offices  
**Level II of sound isolation**



Hotels, hospitals, libraries, living complexes  
**Level III of sound isolation**

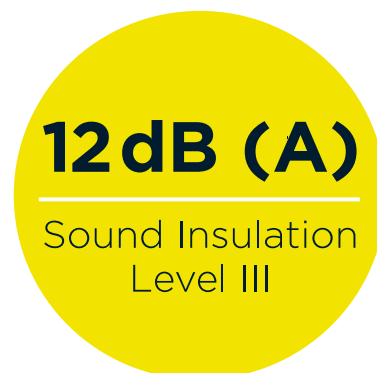

# 6 INTERFERENCE

## TROUBLE SHOOTING

During the exploitation every pipeline can have problems. Obstructions in case of the sewage pipelines can come as leaking, clogging so for that need it is needed to instal revision openings for inspection of the pipeline and it's cleaning if it is needed.



# 7 MAINTENANCE

As fore mentioned in chapter 6 revisiones need to be considered. In maintenance we have regular one and hazard one.

Hazard maintenance is the change of certain elements of pipeline in case of hazard or cleaning from clogging.

Regular maintenance is cleaning the sediments from inner walls of the pipe. These maintenance should be performed by a company certified for maintenance.



# 8 DISMANTLING

DISMANTLE AND REMOVAL

Dismantling and removing the pipeline is done in following manner:

- Drain out the water
- In case the pipes are in the walls, walls are need to be breached and pipe removed from the wall.
- Detach the joints
- If needed cut short the parts for easier manipulation
- Removed parts put on transport vehicle and drive of to place predicted to put away plastic masses so it could be recycled

# 9 POST-USAGE

PROCEDURE IN POST-USAGE

As fore mentioned PP mass for S LINE system can be recycled. By recycling S LINE does not lose it's physical/chemical abilities, so it can be used for various different purposes afterwards.

Pestan is using exclusively compound of high quality only from world know producers.

Plastic masses are bing soted out by code of material so the code for S LINE is:



# 10 ABBREVIATIONS

## LIST OF ABBREVIATIONS

In document is used metric system of measuring units (SI), eg. force unit Newton (N) instead of pound (p) and power unit Watt (W) instead of kcal/h.

Conversion:

$$1 \text{ kp} = 9.80665 \text{ N ili } 1 \text{ kp} \approx 10 \text{ N}$$

$$1 \text{ Mp} = 9806.65 \text{ N ili } 1 \text{ Mp} \approx 10 \text{ kN i } 1 \text{ Mp/m} = 10 \text{ kN/m}$$

$$1 \text{ kp/cm}^2 = 9.80665 \text{ N/cm}^2 = 0.0980665 \text{ N/mm}^2 = 0.0980665 \text{ Mpa ili } 1 \text{ kP/cm}^2 \approx 0.1 \text{ N/mm}^2$$

$$1 \text{ m vodenog stubs} = 0.0980665 \text{ bar ili } 1 \text{ m vodenog stuba} \approx 0.1 \text{ bar}$$

$$1 \text{ kcal/m h step-in} = 1.16 \text{ W/mK (thermal conductivity) or } 1 \text{ kcal/mh stepeni} \approx 1.2 \text{ W/mK}$$

Thermal conductivity is presented in W/mk. Division unit is the same for K and °C because of the difference only exists in the beginning of the scale. In that manner 1 W/m °C is identical to 1 W/mK. K is SI unit for temperature. Temperature in Celsius (t) is different from temperature in K (T) for 273.15 K.

$$t (\text{°C}) = T - T_0 = T - 273.15 \text{ K.}$$

In this document for g is taken 10 m/s, an error of approximately 2% is disregarded. DN is nominal diameter and PN is nominal pressure.

## Dimensions and Units

Dimensions are expressed in mm and / or inches and are specified as a nominal value and the standard size.

d, d1, d2, d3, d4	Diameter	SDR	Standard dimensional ratio ratio:
DN	Nominal diameter	OD / SDR	S
SC	Size of hexagon screws	OD / S	SDR
AL	Number of holes for the screws	OD	Outside diameter
s	Beam hexagonal head bolts	S	Wall thickness
g	Weight in grams		
SP	Quantity in standard packaging	Explanation of Abbreviations	
GP	Quantity in large quantities		
e	Wall thickness	PB	Polybutylene
PN	Nominal pressure	PE	Polyethylene
Rp	Parallel internal pipe thread according to ISO 7-1	PE-X	The cross-linked polyethylene
R	The conical outer pipe thread according to ISO 7-1	PP	Polypropylene
ppm	Pieces per million	PVC	Polyvinylchloride
1 bar	= 0.1 N/mm <sup>2</sup> = 0.1 Mpa (Megapascal) = 14.504 psi	PVC-C	Chlorinated polyvinyl chloride (increased chlorine content)
C	Project factor	PVC-U	Non-plasticised polyvinyl chloride
S	Series of pipes	PVC-O	Oriental polyvinyl chloride
SDR	Standard dimensional ratio		
MFR	Dissolved flow coefficient according to ISO 4440		



# 11 CHEMICAL RESISTANCE

TABLE OF TABLE OF CHEMICAL RESISTANCE

## 11.1 Introduction

Table in this document sums up data of PP chemical resistance, it is used in multiple countries, made as a result of practical experience and test results.

Izvor : ISO/TR 10358

Table contains evaluation of chemical resistance of big number of fluids estimated as aggressive or inert towards PP. Estimation is based upon values gained from tests where the sample of PP is submerged in fluid sample in temperatures 20, 60 i 100°C and atmosphere pressure, following the characteristics of tension rigidity under some conditions.

Classification will be estimated while taking in account limited number of fluids considering technically or commercially more important by using the equipment that enables testing under pressure and estimation of coefficient of chemical resistance separately for each fluid. In this way the tests will give complete information about use of PP pipes for transport of mentioned fluids including their use under pressure.

## 11.2 Field of application

This document contains classification of chemical resistance of PP for about 180 fluids. It is meant to supply with general guidelines about possibilities of use PP pipes for fluid transfer>

In temperatures 20, 60 and 100°C

In absence of inner pressure and outer mechanical tension (bending, distortion for eg.)

## 11.3 Definition and symbols as abbreviations

Criteria of classification, symbols and abbreviations used in this chapter are following:

S – satisfactory L – partially

Chemical resistance of PP exposed to activity of fluids is classified as partially satisfying when the results from around different countries came in.

Also this classification (L) is used for resistance to activity of chemical fluids at which depending on the parameters can be used both S and NS

NS – unsatisfactory

Chemical resistance of PP exposed to activity of fluids is put to NS category when test results from all different countries that participated came in.

In NS category are materials which depending on the parameters have mark NS or L.

Saturated solution - saturated aqueous solution prepared

at 20 ° C

Solution - A unsaturated aqueous solution concentrations higher than 10%

Diluted solution - diluted aqueous solution in concentrations equal to or lower than 10%

A working solution - aqueous solution with the usual concentration for industrial use

Solution concentration recorded in the text are expressed in percentages by weight. Aqueous solutions of

poorly soluble chemicals, regarding chemical activity towards polypropylene, are considered saturated solutions. Overall, in this catalog are used common chemical names.

This table is made as a guide for polypropylene users. In case that a chemical compound is not in the table, or due to uncertainties related to the

chemical resistance in an application, please contact Peštan for advice and testing proposal.



Chemical or Product	Concentration	Temperature °C		
		20	60	100
Acetic acid	up to 40 %	S	S	-
Acetic acid	50%	S	S	L
Acetic acid, glacial	>96%	S	L	NS
Acetic anhydride	100%	S	-	-
Acetone	100%	S	S	-
Acephenone	100%	S	L	-
Acrylonitrile	100%	S	-	-
Air	-	S	S	S
Allyl alcohol	100%	S	S	-
Almond oil	-	S	-	-
Alum	Sol	S	S	-
Ammonia, aqueous	Sat. sol	S	S	-
Ammonia, dry gas	100%	S	-	-
Ammonia, liquid	100%	S	-	-
Ammonium acetate	Sat. sol	S	S	-
Ammonium chloride	Sat. sol	S	S	-
Ammonium fluoride	up to 20%	S	S	-
Ammonium hydrogen carbonate	Sat. sol	S	S	-
Ammonium metaphosphate	Sat. sol	S	S	S
Ammonium nitrate	Sat. sol	S	S	S
Ammonium persulphate	Sat. sol	S	S	-
Ammonium phosphate	Sat. sol	S	-	-
Ammonium sulphate	Sat. sol	S	S	S
Ammonium sulphide	Sat. sol	S	S	-
Amyl acetate	100%	L	-	-
Amyl alcohol	100%	S	S	S
Aniline	100%	S	S	-
Apple juice	-	S	-	-
Aqua regia	HCl/HNO <sub>3</sub> /1	NS	NS	NS
Barium bromide	Sat. sol	S	S	S
Barium carbonate	Sat. sol	S	S	S



Chemical or Product	Concentration	Temperature °C		
		20	60	100
Barium chloride	Sat. sol	S	S	S
Barium hydroxide	Sat. sol	S	S	S
Barium sulphide	Sat. sol	S	S	S
Beer	-	S	S	-
Benzene	<b>100%</b>	L	NS	NS
Benzoic acid	Sat. sol	S	S	-
Benzyl alcohol	100%	S	L	-
Borax	sol	S	S	-
Boric acid	Sat. sol	S	-	-
Boron trifluoride	Sat. sol	S	-	-
Bormine, gas	-	NS	NS	NS
Bromine, liquid	100%	NS	NS	NS
Butane, gas	100%	S	-	-
Butanol	100%	S	L	L
Butyl acetate	100%	L	NS	NS
Butyl glycol	100%	S	-	-
Butil fenol	Sat. sol	S	-	-
Butyl phenols	100%	S	L	L
Calcium carbonate	Sat. sol	S	S	S
Calcium chlorate	Sat. sol	S	S	-
Calcium chlorate	Sat. sol	S	S	S
Calcium hydroxide	Sat. sol	S	S	S
Calcium hypochlorite	sol	S	-	-
Calcium nitrate	Sat. sol	S	S	-
Camphor oil	-	NS	NS	NS
Carbon dioxide, dry gas	-	S	S	-
Carbon dioxide, wet gas	-	S	S	-
Carbon disulphide	100%	S	NS	NS
Carbon monoxide, gas	-	S	S	-
Carbon tetrachloride	100%	NS	NS	NS
Castor oil	100%	S	S	-
Caustic soda	Up to 50%	S	L	L
Chlorine, aqueous	Sat. sol	S	L	-
Chlorine, dry gas	100%	NS	NS	NS

Chemical or Product	Concentration	Temperature °C		
		20	60	100
Chlorine, liquid	100%	NS	NS	NS
Chloroacetic acid	100%	S	-	-
Chloroethanol	100%	S	-	-
Chloroform	100%	L	NS	NS
Chlorosulphonic acid	100%	NS	NS	NS
Chrome alum	Sol	S	S	-
Chromic acid	Up to 40%	S	L	NS
Citric acid	Sat. sol	S	S	S
Coconut oil	-	S	-	-
Copper (II) chloride	Sat. sol	S	S	-
Copper (II) nitrate	Sat. sol	S	S	S
Copper (II)	Sat. sol	S	S	-
Corn oil	-	S	L	-
Cottonseed oil	-	S	S	L
Cresol	Greater than 90%	S	-	-
Cyclohexane	100%	S	-	-
Cyclohexanol	100%	S	L	-
Cyclohexanone	100%	L	NS	NS
Decalin (decahydronaphthalene)	100%	NS	NS	NS
Dextrin	Sol	S	S	-
Dextrin Dextrose	Sol	S	S	S
Dibutyl phthalate	100%	S	L	NS
Dichloroacetic acid	100%	L	-	-
Dichloroethylene (A and B)	100%	L	-	-
Diethanolamine	100%	S	-	-
Diethyl ether	100%	S	L	-
Diethylene glycol	100%	S	S	-
Diglycolic acid	100%	S	-	-
Diisooctyl	100%	S	L	-
Dimethyl amine, gas	-	S	-	-
Dimethyl formamide	100%	S	S	-
Diocetyl phthalate	100%	L	L	-
Dioxane	100%	L	L	-
Distilled water	100%	S	S	S



Chemical or Product	Concentration	Temperature °C		
		20	60	100
Ethyl alcohol	Up to 95%	S	S	S
Ethyl chloride, gas	-	NS	NS	NS
Ethylene chloride (mono and di)	-	L	L	-
Ethyl ether	100%	S	L	-
Ethylene glycol	100%	S	S	S
Ethanolamine	100%	S	-	-
Ethyl acetate	100%	L	NS	NS
Ferric chloride	Sat. sol	S	S	S
Ferric chloride Formaldehyde	40%	S	-	-
Formic acid	10%	S	S	L
Formic acid	85%	S	NS	NS
Formic acid, anhydrous	100%	S	L	L
Fructose	Sol	S	S	S
Fruit juice	-	S	S	S
Gasoline. petrol (aliphatic hydrocarbons)	-	NS	NS	NS
Gelatine	-	S	S	-
Glucose	20%	S	S	S
Glycerine	100%	S	S	S
Glycolic acid	30%	S	-	-
Heptane	100%	L	NS	NS
Hexane	100%	S	L	-
Hydrobromic acid	More than 48%	S	L	NS
Hydrochloric acid	More than 20%	S	S	S
Hydrochloric acid	30%	S	L	L
Hydrochloric acid	From 35 to 36%	S	-	-
Hydrofluoric acid	Dil.sol	S	-	-
Hydrofluoric acid	40%	S	-	-
Hydrogen	100%	S	-	-
Hydrogen chloride, dry gas	100%	S	S	-
Hydrogen peroxide	Up to 10%	S	-	-
Hydrogen peroxide	Up to 30%	S	L	-
Hydrogen sulphide, dry gas	100%	S	S	-
Iodine, in alcohol	-	S	-	-

Chemical or Product	Concentration	Temperature °C		
		20	60	100
Isoctane	100%	L	NS	-
Isopropyl alcohol	100%	S	S	S
Isopropyl ether	100%	L	-	-
Lactic acid	Up to %	S	S	-
Lanoline	-	S	L	-
Linseed oil	-	S	S	S
Magnesium carbonate	Sat. Sol	S	S	S
Magnesium chloride	Sat. Sol	S	S	-
Magnesium hydroxide	Sat. Sol	S	S	-
Magnesium sulphate	Sat. Sol	S	S	-
Maleic acid	Sat. Sol	S	S	-
Mercury (II) chloride	Sat. Sol	S	S	-
Mercury (II) cyanide	Sat. Sol	S	S	-
Mercury (I) nitrate	Sol	S	S	-
Mercury	100%	S	S	-
Methyl acetate	100%	S	S	-
Methyl alcohol	5%	S	L	-
Methyl amine	Up to 32%	S	-	-
Methyl bromide	100%	NS	NS	NS
Methyl ethyl ketone	100%	S	-	-
Methylene chloride	100%	L	NS	NS
Milk	-	S	S	S
Monochloroacetic acid	<85%	S	S	-
Naphtha	-	S	NS	NS
Nickel chloride	Sat. Sol	S	S	-
Nickel nitrate	Sat. Sol	S	S	-
Nickel sulphate	Sat. Sol	S	S	-
Nitric acid	Up to 30%	S	NS	NS
Nitric acid	From 40 to 50%	L	NS	NS
Nitric acid, fuming (with nitrogen dioxide)	-	NS	NS	NS
Nitrobenzene	100%	S	L	-
Oleic acid	100%	S	L	-



Chemical or Product	Concentration	Temperature °C		
		20	60	100
Oleum (sulphuric acid with 60 % of SO <sub>3</sub> )	-	S	L	-
Olive oil	-	S	S	L
Oxalic acid	Sat. Sol	S	L	NS
Oxygen, gas	-	S	-	-
Parafin oil (FL65)	-	S	L	NS
Peanut oil	-	S	S	-
Peppermint oil	-	S	-	-
Perchloric acid	(2N) 20%	S	-	-
Petroleum ether (ligroine)	-	L	L	-
Phenol	5%	S	S	-
Phenol	90%	S	-	-
Phosphine, gas	-	S	S	-
Phosphoric acid	Up to 85%	S	S	S
Phosphorus oxychloride	100%	L	-	-
Picric acid	Sat. Sol	S	-	-
Potassium bicarbonate	Sat. Sol	S	S	S
Potassium borate	Sat. Sol	S	S	-
Potassium bromate	Up to 10%	S	S	-
Potassium bromide	Sat. Sol	S	S	-
Potassium carbonate	Sat. Sol	S	S	-
Potassium chlorate	Sat. Sol	S	S	-
Potassium chlorite	Sat. Sol	S	S	-
Potassium chromate	Sol	S	S	-
Potassium cyanide	Sat. Sol	S	-	-
Potassium dichromate	Sat. Sol	S	S	S
Potassium ferricyanide	Sat. Sol	S	S	-
Potassium fluoride	Up to 50%	S	S	-
Potassium hydroxide	Sat. Sol	S	S	S
Potassium iodide	Sat. Sol	S	-	-
Potassium nitrate	10%	S	S	-
Potassium perchlorate	(2N) 30%	S	S	-
Potassium permanganate	Sat. Sol	S	-	-
Potassium persulphate	Sat. Sol	S	S	-

Chemical or Product	Concentration	Temperature °C		
		20	60	100
Potassium sulphate	100%	S	S	-
Propane, gas	<50%	S	-	-
Propionic acid	-	S	-	-
Pyridine	100%	L	-	-
Seawater	-	S	S	S
Silicon oil	-	S	S	S
Silver nitrate	Sat. Sol	S	S	L
Sodium acetate	Sat. Sol	S	S	S
Sodium benzoate	35%	S	L	-
Sodium bicarbonate	Sat. Sol	S	S	S
Sodium carbonate	Do 50%	S	S	L
Sodium chlorate	Sat. Sol	S	S	-
Sodium chloride	Sat. Sol	S	S	-
Sodium chlorite	2%	S	L	NS
Sodium chlorite	20%	S	L	NS
Sodium dichromate	Sat. Sol	S	S	S
Sodium hydrogen carbonate	Sat. Sol	S	S	S
Sodium hydrogen sulphate	Sat. Sol	S	S	-
Sodium hydrogen sulphite	Sat. Sol	S	-	-
Sodium hydroxide	1%	S	S	S
Sodium hydroxide	From 10 to 60%	S	S	S
Sodium hypochlorite	5%	S	S	-
Sodium hypochlorite	From 10 to 15%	S	-	-
Sodium hypochlorite	20%	S	L	-
Sodium metaphosphate	Sol	S	-	-
Sodium nitrate	Sat. Sol	S	S	-
Sodium perborate	Sat. Sol	S	S	-
Sodium phosphate (neutral)	-	S	S	S
Sodium silicate	Sol	S	S	-
Sodium sulphate	Sat. Sol	S	S	-
Sodium sulphate	Sat. Sol	S	-	-
Sodium sulphite	40%	S	S	S
Sodium thiosulphate (hypo)	Sat. Sol	S	-	-
Soybean oil	-	S	L	-



Chemical or Product	Concentration	Temperature °C		
		20	60	100
Succinic acid	Sat. Sol	S	S	-
Sulphuric acid	Up to 10%	S	S	S
<b>Sulphuric dioxide, dry or wet</b>	100%	S	S	-
Sulphur acid	From 10 to 30%	S	S	-
Sulphur acid	50%	S	L	L
Sulphur acid	96%	S	L	NS
Sulphur acid	98%	L	NS	NS
Sulphurous acid	Up to 30%	S	-	-
Tartaric acid	Sat. Sol	S	S	-
Tetrahydrofuran	100%	L	NS	NS
Tetralin	100%	NS	NS	NS
Thiophene	100%	S	L	-
Tin (IV) chloride	Sol	S	S	-
Tin (II) chloride	Sat. Sol	S	S	-
Toluene	100%	L	NS	NS
Trichloroacetic acid	Up to 50%	S	S	-
Trichloroethylene	100%	NS	NS	NS
Triethanolamine	Sol	S	-	-
Turpentine		NS	NS	NS
Urea	Sat. Sol	S	S	-
Vinegar	-	S	S	-
Water brackish, mineral, potable	-	S	S	S
Whiskey		S	S	-
Wines		S	S	-
Xylene	100%	NS	NS	NS
Yeast	Sol	S	S	S
Zinc chloride	Sat. Sol	S	S	-
Zinc sulphate	Sat. Sol	S	S	-



## Disclaimer

The information contained in this catalog to our the information is accurate and reliable as of the day of publication. Peštan does not provide a guarantee and gives no explanation for accuracy or completeness of the information contained here, and assumes no liability in connection with the consequences of their use or for any misprint. Our products are intended for general consumption. The responsibility of the buyer is to inspect and test our products in order to ascertain the suitability of the product for customer's particular purpose. The buyer is also responsible for appropriate, safe and legal use, processing and handling our product. Here, nothing provides a guarantee. There is no liability that can be accepted and refers to the use of Peštan products in conjunction with other

materials. The information contained in this catalog refers exclusively to our products when not used in conjunction with any third party.

Peštan points out that data on the chemical resistance of Polypropylene displayed in the list of chemical resistance in this catalog are based on data collected from several sources. Peštan does not guarantee the correctness and accuracy such data and accepts no liability of any loss or damage as a result of use, inability to use or the result of using catalog by the customer or any third party to whom such data can be transmitted. You are obliged to enable suitable test to ensure convenience and safety products for the intended use in accordance with applicable regulations.

# 12 CERTIFICATES



IGH Hrvatska



Fraunhofer Nemačka



IMS Srbija



# PRODUCTION PROGRAM

S LINE pipes & fittings od  $\varnothing 32$  do  $\varnothing 160$





# S LINE

production program

Pipe with single socket

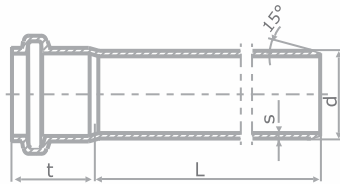

Pipe with double socket

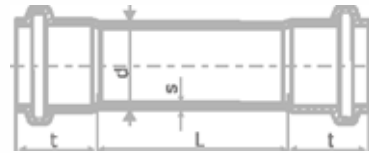

D	L	S	D	L	S
32	150	1,8	90	150	2,8
	250			250	
	500			500	
	750			750	
	1000			1000	
	1500			1500	
	2000			2000	
	2500			2500	
	3000			3000	
	4000			4000	

D	L	S	D	L	S
32	500	1,8	90	500	2,8
	750			750	
	1000			1000	
	1500			1500	
	2000			2000	
	2500			2500	
	3000			3000	
	4000			4000	

D	L	S	D	L	S
40	150	1,8	110	150	3,4+0,4
	250			250	
	500			500	
	750			750	
	1000			1000	
	1500			1500	
	2000			2000	
	2500			2500	
	3000			3000	
	4000			4000	

D	L	S	D	L	S
40	500	1,8	110	500	3,4+0,4
	750			750	
	1000			1000	
	1500			1500	
	2000			2000	
	2500			2500	
	3000			3000	
	4000			4000	

D	L	S	D	L	S
50	150	1,8	125	150	3,9
	250			250	
	500			500	
	750			750	
	1000			1000	
	1500			1500	
	2000			2000	
	2500			2500	
	3000			3000	
	4000			4000	

D	L	S	D	L	S
50	500	1,8	125	500	3,9
	750			750	
	1000			1000	
	1500			1500	
	2000			2000	
	2500			2500	
	3000			3000	
	4000			4000	

D	L	S	D	L	S
75	150	2,3	160	150	4,9
	250			250	
	500			500	
	750			750	
	1000			1000	
	1500			1500	
	2000			2000	
	2500			2500	
	3000			3000	
	4000			4000	

D	L	S	D	L	S
75	500	2,3	160	500	4,9
	750			750	
	1000			1000	
	1500			1500	
	2000			2000	
	2500			2500	
	3000			3000	
	4000			4000	

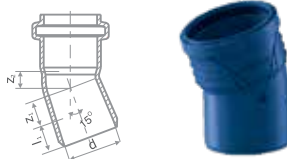
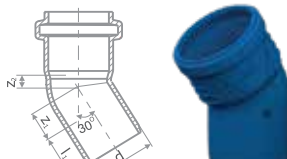
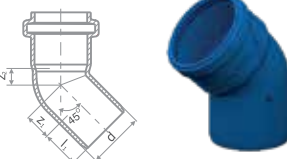
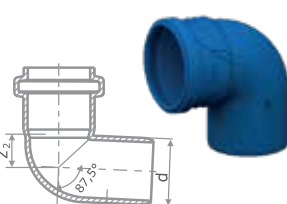

CODE	DESCRIPTION	PICTURE	Z <sub>1</sub>	Z <sub>2</sub>	L <sub>1</sub> MIN	D
<b>S LINE BEND 15°</b>						
10304000	Silent bent HTB 32/15°		25	8.45	25	32
10304001	Silent bent HTB 40/15°		26.5	8.97	26.5	40
10304002	Silent bent HTB 50/15°		29.005	8.26	29.005	50
10304003	Silent bent HTB 75/15°		31.79	12.01	37.79	75
10304004	Silent bent HTB 90/15°		33.5	13.83	33.5	90
10304005	Silent bent HTB 110/15°		40.885	16.34	40.885	110
10304006	Silent bent HTB 125/15°		43.84	19.52	43.84	125
10304007	Silent bent HTB 160/15°		47.915	23.05	47.915	160
<b>S LINE BEND 30°</b>						
10304020	Silent bent HTB 32/30°		25	10.4	25	32
10304021	Silent bent HTB 40/30°		26.5	11.5	26.5	40
10304022	Silent bent HTB 50/30°		30.57	11.24	30.57	50
10304023	Silent bent HTB 75/30°		29.5	16.69	29.5	75
10304024	Silent bent HTB 90/30°		33.5	19.58	33.5	90
10304025	Silent bent HTB 110/30°		44.385	21.66	44.385	110
10304026	Silent bent HTB 125/30°		47.81	27.06	47.81	125
10304027	Silent bent HTB 160/30°		53.01	32.43	53.01	160
<b>S LINE BEND 45°</b>						
10304040	Silent bent HTB 32/45°		27.88	11.97	27.88	32
10304041	Silent bent HTB 40/45°		30.205	14.64	30.205	40
10304042	Silent bent HTB 50/45°		32.245	14.89	32.245	50
10304043	Silent bent HTB 75/45°		36.705	22.05	36.705	75
10304044	Silent bent HTB 90/45°		42.18	25.7	42.18	90
10304045	Silent bent HTB 110/45°		48.145	30.92	48.145	110
10304046	Silent bent HTB 125/45°		52.075	35.6	52.075	125
10304047	Silent bent HTB 160/45°		58.47	44.24	58.47	160
<b>S LINE BEND 67,5°</b>						
10304060	Silent bent HTB 32/67,5°		29.645	16.03	29.645	32
10304061	Silent bent HTB 40/67,5°		32.48	18.71	32.48	40
10304062	Silent bent HTB 50/67,5°		35.15	21.03	35.15	50
10304063	Silent bent HTB 75/67,5°		41.125	30.49	41.125	75
10304064	Silent bent HTB 90/67,5°		47.5	36.39	47.5	90
10304065	Silent bent HTB 110/67,5°		54.67	43.68	54.67	110
10304066	Silent bent HTB 125/67,5°		59.475	51.07	59.475	125
10304067	Silent bent HTB160/67,5°		67.955	63.7	67.955	160
<b>S LINE BEND 87,5°</b>						
10304080	Silent bent HTB 32/87,5°		31.655	20.09	31.655	32
10304081	Silent bent HTB 40/87,5°		35.07	23.77	35.07	40
10304082	Silent bent HTB 50/87,5°		38.46	27.59	38.46	50
10304083	Silent bent HTB 75/87,5°		46.155	40.69	46.155	75
10304084	Silent bent HTB 90/87,5°		54.055	48.65	54.055	90
10304085	Silent bent HTB 110/87,5°		62.1	58.545	62.1	110
10304086	Silent bent HTB 125/87,5°		67.905	68.15	67.905	125
10304087	Silent bent HTB 160/87,5°		43	84.73	43	160



CODE	DESCRIPTION	PICTURE	Z <sub>1</sub>	Z <sub>2</sub>	Z <sub>3</sub>	L <sub>1</sub> MIN	D
<b>S LINE BRANCH 45°</b>							
10304100	Silent branch HTEA 32/32/45°		6.78	47.68	47.6	47.22	32
10304101	Silent branch HTEA 40/32/45°		2.64	54.48	53.64	52	40
10304102	Silent branch HTEA 40/40/45°		8.28	59.24	59.41	49.72	40
10304103	Silent branch HTEA 50/32/45°		2.14	61.09	57.72	48.1	50
10304104	Silent branch HTEA 50/40/45°		3.59	64.95	64.5	55	50
10304105	Silent branch HTEA 50/50/45°		10.36	70.52	70.49	63	50
10304106	Silent branch HTEA 75/40/45°		9.22	84.015	78.12	46.5	75
10304107	Silent branch HTEA 75/50/45°		2.14	88.4	85.84	54	75
10304108	Silent branch HTEA 75/75/45°		15.53	103.97	103.79	70	75
10304109	Silent branch HTEA 90/50/45°		9.64	98.49	90.32	54	90
10304110	Silent branch HTEA 90/75/45°	8.03	113.31	110.37	72	90	
10304111	Silent branch HTEA 90/90/45°		18.64	120.98	120.94	81.5	90
10304112	Silent branch HTEA 110/40/45°		26.72	107.36	96.65	42	110
10304113	Silent branch HTEA 110/50/45°		19.64	112.46	120.74	49	110
10304114	Silent branch HTEA 110/75/45°		1.97	127.72	121.75	67	110
10304115	Silent branch HTEA 110/90/45°		8.64	136.75	132.65	76	110
10304116	Silent branch HTEA 110/110/45°		22.78	146.67	145.67	92.5	110
10304117	Silent branch HTEA 125/90/45°		1.14	146.65	140.05	75	125
10304118	Silent branch HTEA 125/110/45°		15.28	159.68	156.64	89	125
10304119	Silent branch HTEA 125/125/45°		25.89	169.58	170.03	100	125
10304120	Silent branch HTEA 160/110/45°		2.22	185.82	174.3	78	160
10304121	Silent branch HTEA 160/125/45°		8.39	193.75	188.78	89	160
10304122	Silent branch HTEA 160/160/45°		33.14	213.57	213.49	114	160
<b>S LINE RAČVA 87,5°</b>							
10304130	Silent branch HTEA 32/32/87.5°		15.3	22.51	22.53	47.86	32
10304132	Silent branch HTEA 40/40/87.5°		19.08	27.3	27.62	49.92	40
10304134	Silent branch HTEA 50/40/87.5°		19.96	30.47	27.35	50.06	50
10304135	Silent branch HTEA 50/50/87.5°		23.93	31.37	31.57	52.07	50
10304136	Silent branch HTEA 75/40/87.5°		16.84	42.925	29.66	55.58	75
10304137	Silent branch HTEA 75/50/87.5°		23.39	43.57	35.96	55.47	75
10304138	Silent branch HTEA 75/75/87.5°		35.9	46.23	46.72	56.1	75
10304139	Silent branch HTEA 90/50/87.5°		23.06	51.07	68.31	64.44	90
10304140	Silent branch HTEA 90/75/87.5°		35.57	53.17	47.06	63.63	90
10304141	Silent branch HTEA 90/90/87.5°		43.08	55.3	55.41	63.42	90
10304142	Silent branch HTEA 110/40/87.5°		17.62	61.475	30.465	68.53	110
10304143	Silent branch HTEA 110/50/87.5°		22.62	62.2	35.82	69.4	110
10304144	Silent branch HTEA 110/75/87.5°		35.13	63.11	47.49	69.75	110
10304145	Silent branch HTEA 110/90/87.5°		42.6	63.32	56.25	70.75	110
10304146	Silent branch HTEA 110/110/87.5°		52.65	65.19	65.96	70.84	110
10304147	Silent branch HTEA 125/90/87.5°		42.31	72.485	70.79	73.79	125
10304148	Silent branch HTEA 125/110/87.5°		52.48	75.05	66.48	73.19	125
10304149	Silent branch HTEA 125/125/87.5°		59.83	73.99	74.55	73.17	125
10304150	Silent branch HTEA 160/110/87.5°		51.67	89.79	70.39	80.45	160
10304151	Silent branch HTEA 160/125/87.5°		59.07	93.12	77.12	80.06	160
10304152	Silent branch HTEA 160/160/87.5°		76.58	98.97	98.44	80.42	160



**S LINE ARCH BRANCH 87,5°**

10304240	Silent arch branch HTEA 90/90/87.5°		52.13	65.85	53	63.07	90
10304241	Silent arch branch HTEA 110/90/87.5°		49.89	77.35	53.42	74.9	110
10304242	Silent arch branch HTEA 110/110/87.5°		60.53	80.51	61.35	74.54	110

CODE	DESCRIPTION	PICTURE	Z <sub>1</sub>	Z <sub>2</sub>	Z <sub>3</sub>	L <sub>1</sub> MIN	D
------	-------------	---------	----------------	----------------	----------------	--------------------	---

**S LINE DOUBLE BRANCH 45°**

10304190	Silent double branch HTDA 50/90/50-45°		25.25	45	25.25	54	90
10304191	Silent double branch HTDA 50/110/50-45°		25.25	55.45	25.25	49	110

**S LINE INSPECTION BRANCH**

10304178	Silent inspection branch HTRE 50		25		31.46	51	50
10304179	Silent inspection branch HTRE 75		37.5		46.74	54.5	
10304180	Silent inspection branch HTRE 90		46.44		55.83	62.06	90
10304181	Silent inspection branch HTRE 110		55		66.15	68.5	110
10304182	Silent inspection branch HTRE 125		62.5		75.53	70.5	125
10304183	Silent inspection branch HTRE 160		80		98.78	77	160

CODE	DESCRIPTION	PICTURE	L	D	DESCRIPTION	PICTURE	CODE	L	D
------	-------------	---------	---	---	-------------	---------	------	---	---

**S LINE DOUBLE SOCKET**

**S LINE SLIP COUPLER**

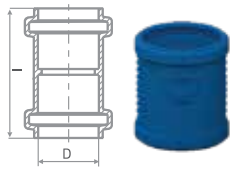
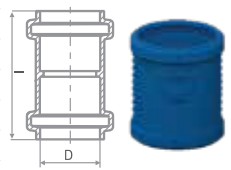
10304200	Silent double socket HTM 32		96.9	32.7	Silent slip coupler HTU 32		10304220	96.9	32.7
10304201	Silent double socket HTM 40		104	40.7	Silent slip coupler HTU 40		10304221	104	40.7
10304202	Silent double socket HTM 50		110	50.7	Silent slip coupler HTU 50		10304222	110	50.7
10304203	Silent double socket HTM 75		119	76	Silent slip coupler HTU 75		10304223	119	76
10304204	Silent double socket HTM 90		131	90	Silent slip coupler HTU 90		10304224	131	90
10304205	Silent double socket HTM 110		147	111	Silent slip coupler HTU 110		10304225	147	111
10304206	Silent double socket HTM 125	157	126	Silent slip coupler HTU 125	10304226	157	126		

CODE	DESCRIPTION	PICTURE	Z1	L1MIN	D	D1
<b>S LINE EXCENTRIC REDUCER</b>						
10304160	Silent reducer HTR 40/32		15.19	54.88	40	32.7
10304161	Silent reducer HTR 32/40		10.435	54.88	40	36.9
10304163	Silent reducer HTR 40/50		17.32	57.88	50	40.7
10304164	Silent reducer HTR 50/40		17.32	57.88	50	40.7
10304165	Silent reducer HTR 75/50		20.94	62.26	75	50.7
10304177	Silent reducer HTR 90/40		19.17	71.16	90	44.9
10304166	Silent reducer HTR 90/50		16.34	70.36	90	54.9
10304167	Silent reducer HTR 90/75		19.1	71.54	90	81
10304168	Silent reducer HTR 90/110		13.025	77.48	110	96.8
10304169	Silent reducer HTR 90/125		13.365	81.51	125	96.8
10304170	Silent reducer HTR 110/40		9.95	77.63	110	44.9
10304171	Silent reducer HTR 110/50		16.89	76.81	110	50.7
10304172	Silent reducer HTR 110/75		19.79	77.54	110	76
10304173	Silent reducer HTR 125/110		19.03	82.63	125	111
10304175	Silent reducer HTR 160/125		22.94	92.09	160	126

