

TECHNICAL CATALOGUE
SPIROPIPE
PE AND PP SPIRAL PIPES



March 2020.

CONTENT

GENERAL NOTICE	3
ABOUT COMPANY	5
BASIC PEŠTAN SPIROPIPE DATA	7
PRODUCT RANGE	9
TECHNICAL SPECIFICATION	12
SPIRO PIPE PE AND PP STANDARDS	21
PACKAGING, TRANSPORT AND STORAGING	22
ADVANTAGES OF SPIROPIPE SYSTEM	23
USEFUL LINKS	24

GENERAL NOTICE

The technical catalog is subject to change in certain time intervals as a consequence of adopting new products and modifications of the same. For this reason it is necessary to make sure you have the latest version of catalog. The technical catalog release date is on the catalog cover and the latest version you can download from www.pestan.net or request it through email office@pestan.net.

Quick access to chapters is provided with help of pictograms.

**Important
information**



**Safety
recommendation**



**Legal
notice**



Before you start with the installation of Peštan SPIROPIPE sewer pipes be sure that you read all recommendations related to safety and protection at work all for your purpose safety and security and those around you. You should keep this instruction with you during the installation. For more information regarding some details from this technical catalogue please contact us via e-mail at office@pestan.net.

General safety recommendations:

- Consider all general security rules for preventing accidents when installing pipes and fittings
- Provide sufficient light when installing pipes and fitting
- Keep your workspace clean
- Keep children, pets and unauthorized persons away from tools and pipes and fittings (this is special important in case of renovation)

System Setup Measures:

- If you have jewelry on or other items similar items, make sure to remove them before installation.
- Cutting tools should be properly disposed and used with great care because they have sharp edges.
- When shortening pipes, a safe distance should be maintained between the hand holding the pipe and the cutting tool, and never place your hands near the part where the tool cuts
- When doing service, maintenance, or relocation, when assembling, always turn off the power on the tool..

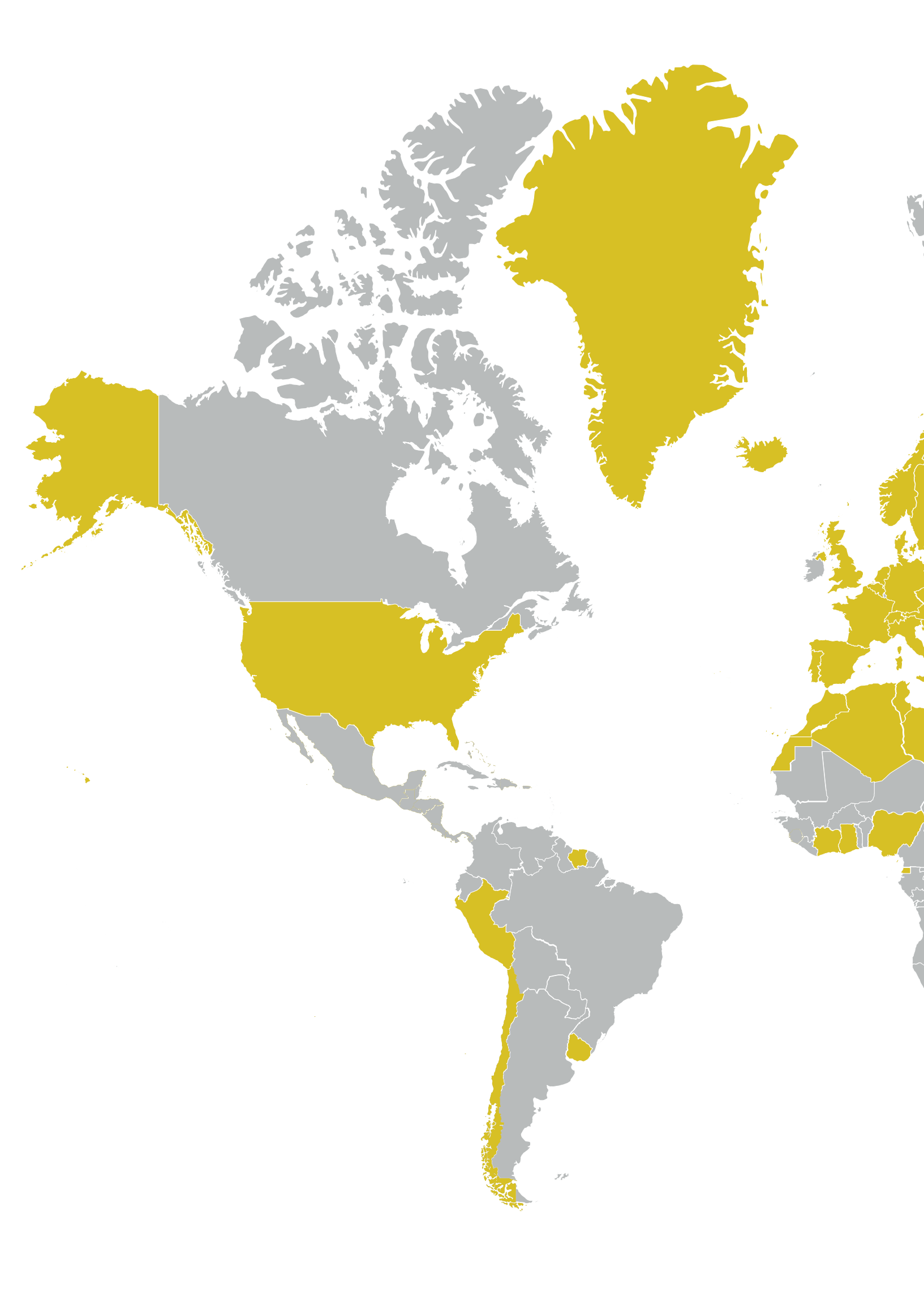



ABOUT US

The private company Peštan is the leader in the Balkans in production of plastic pipes and fittings for water, sewage and gas.

The company was founded in 1989 and was engaged in production of polyethylene water pipes. Over time, it introduced new materials (polypropylene and PVC) and expanded the production program. In offer today you can find over 5000 products, from pipes and fittings and PVC profiles, through luxurious and modern drains, to irrigation tapes.

Production facilities are located in Arandjelovac, 70 kilometers south of Belgrade, and foreign representations in the countries in the region are: Bosnia and Herzegovina, Romania, Croatia as well as in Ukraine and the UAE.

The company is present on the market of Europe, Russia, the Middle East, North Africa, Latin America and the United States. It is export-oriented and sells in over 70 countries around the world!

PEŠTAN is established and organized Company certified according to the requirements of the Integrated Management System,

- ISO 9001 quality management (since 2004)
- Environmental Management, ISO 14001 (since 2010)
- OHSAS occupational health and safety management 18001 (since 2010)

PEŠTAN is certified with its products accordingly to normative regulations at the most eminent certification bodies: DVGW, MPA, SABS, BULGARKONTROLA, EBETAM, IGH, VUPS, VUSAPL, ICC, SKZ, EMI...

In order to meet the needs of customers as much as possible, the company continuously introduces innovations and improves staff and equipment. Since 2009 the SAP ERP system with MM, SD, PP modules is introduced to the company, FI | CO, and since 2012 the functionalities have been expanded with WMS. The introduction of WCM and WMS systems has increased efficiency, contributed it's cost allocation and professional maintenance. Since 2015 is implemented in SAP and the quality management module (QM).

Employees' of the company Peštan, of which there are over 1000, joint efforts justify the company's slogan: WE BUILD TRUST

1 INFORMATIONS

GENERAL INFORMATION ABOUT
PEŠTAN SPIRAL PIPES

Spiral two-layer corrugated pipes are made of high density polyethylene or polypropylene. They consist of an inner smooth wall and an outer corrugated spiral wall. The pipe is produced by winding a profiled outer layer (reinforcements) with corrugated profile on smooth and inner layer that is extruded and welded continuously. The outer layer consists of a smaller ribbed intestine high strength coated with polyethylene or polypropylene, and the

inner layer consists of high density polyethylene or polypropylene. Presence profiled hose in the outer layer significantly improves the strength of the pipe itself. Technology production allows different steps (profiles) when winding the profiled outer layer, which provides different pipe strengths. Exactly from that reasons PEŠTAN spiral corrugated pipes can be produced in different types of stiffness. produce in different strength classes.

PHYSICAL PROPERTIES OF MATERIALS

Impact resistance

High impact resistance even at low temperature, which is a feature of these materials, guarantees compactness and strength of products that are made entirely of the highest quality materials. Reference procedure for determining resistance to strokes is EN 744.

Better hydraulic characteristics

Internal diameters and hydraulic characteristics PEŠTAN PE and PP SPIRAL pipes SPIROPIPE remain the same over time, regardless of the type of profile, thanks to greatly reduced roughness and low adhesiveness of the inner walls of the pipe. Nominal diameter corresponds to the inner diameter of the pipe, with the allowable deviations according to reference norms.

UV resistance

Black polyethylene pipes are weather resistant to effects of UV radiation, thanks to the addition of soot which is evenly dispersed in the polymer base. Therefore, such pipes can be used and be stored in open space, until an appropriate period of time, without damaging the material. Blue polypropylene pipes are partially resistant to UV radiation, can be stored outdoors, but in for a limited period of time (up to 6 months).

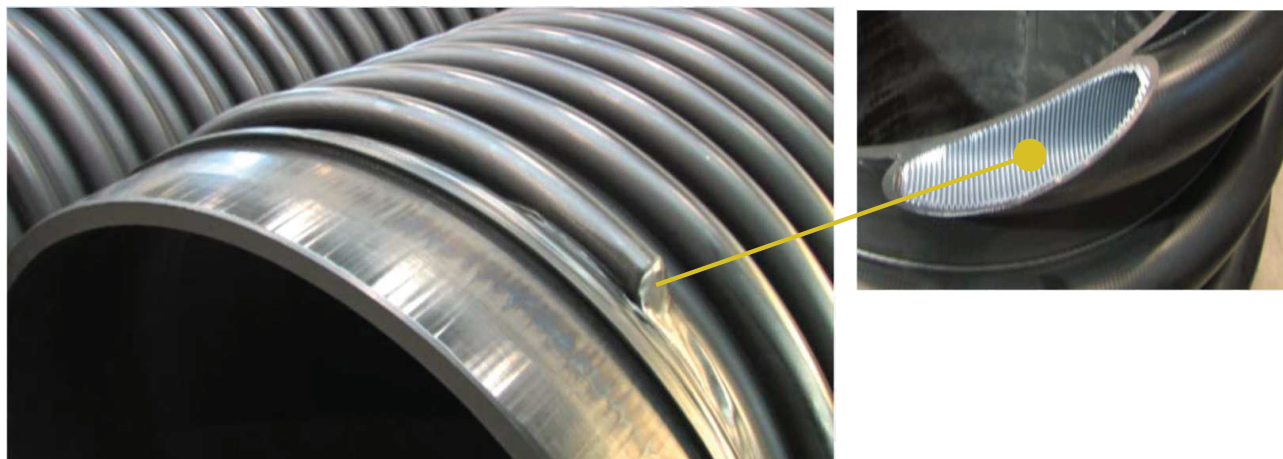



Physical properties of PE material

- The density 959 g/cm³, according ISO 1183
- Stretching module 1050 MPa, according ISO 527
- MRS classification 10 MPa, according ISO12162
- Impact strength to Sharpie 23 MPa, according ISO 179
- Vicat softening temperature 71 °C, according ISO 306
- Coefficient of linear thermal elongation 0.13 mm/m °C.

Chemical resistance of material

PEŠTAN PE SPIRAL pipes SPIROPIPE are resistant to salty water, alcohol, acids, alkalines, sulfates, aggressive gases and all kinds of detergents. On the other hand, can not be used for transport of water which contains high percentage of benzene, benzine (petrol) or acetone.

Physical properties of materials PP

- The density 900 gr/cm³, according to ISO 1183
- Modules of stretching 1300 MPa, according to ISO 527
- Tensile load 28 MPa, according to ISO 527
- Impact strength to Sharpie 70 kJ/m², according to ISO 179

Temperature resistance of materials

PE pipes are resistant to temperatures up to 60 degrees short-term, and 40 degrees long-term.

Polypropylene as material, has high temperature resistance, therefore the pipes made of this material also have heightened temperature load resistance. PP SPIRAL SPIROPIPE pipes are resistant to temperature up to 95 degrees short-term and 60 degrees long-term.

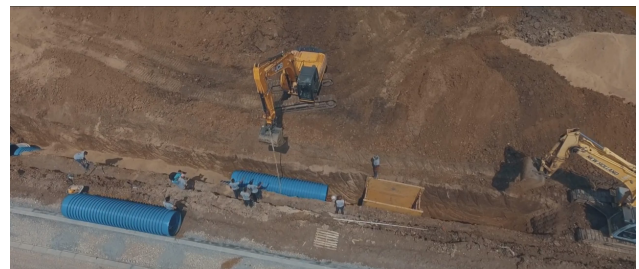
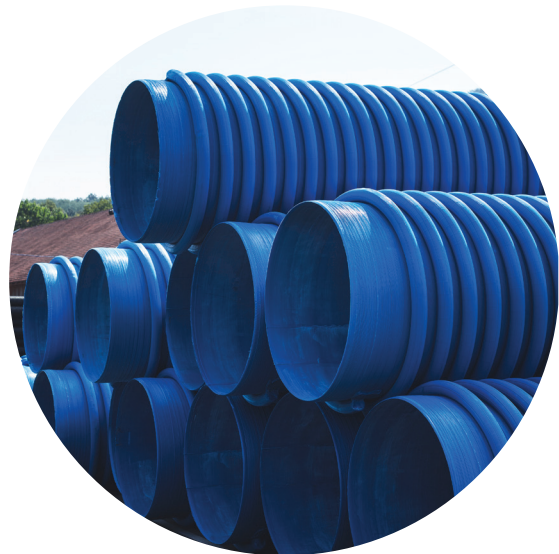

PE Pipes

PP Pipes

2 PRODUCTION PROGRAM

PEŠTAN PE SPIRAL pipes SPIROPIPE for large sewer systems or non-critical transport of water includes two groups of pipes made of the highest quality polyethylene (PE SPIROPIPE) or propylene (PP SPIROPIPE) with profiled ones with reinforcement in the ribs, in diameters of Ø300 up to Ø3000.

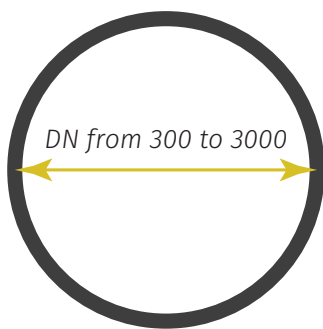

PE SPIROPIPE pipes

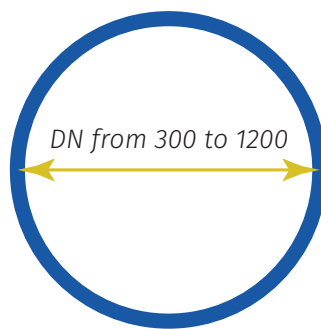

PP SPIROPIPE pipes



DN / ID = inner diameter [mm]
L = installation length [mm]

Also, these pipes are produced in standard length of 6m. They can also be produced in other lengths according to project specification.

PEŠTAN SPIRAL pipes SPIROPIPE are produced in more variants of strength (resistance) to the external load (depending on the step of the profiled outer layer of reinforcement, as well as on diameter). They are produced from SN2 up to SN32.

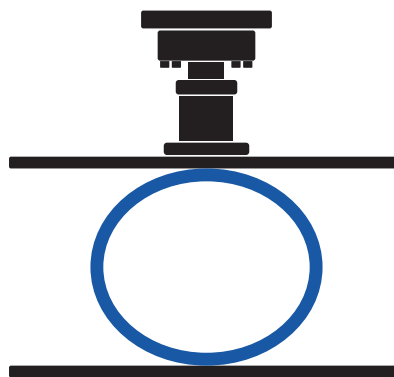

From SN 2 to SN 32

Ring stiffness		
Ring stiffness	Formula	Explanation
According to DIN 16961	$RS_{24} = \frac{E_{24} \cdot I_x}{(r+e)^3} \text{ [N/mm}^2\text{]}$	E_{24} - elastic modulus after 24h in N/mm I_x - moment of inertia of profile in mm ⁴ /mm r - inside radius in mm
According to DIN 9969	$SN = \frac{E_k \cdot I_x}{(d+2e)^3} \text{ [N/mm}^2\text{]}$	E_k - elastic modulus after 1 minute in N/mm r - pipe inner radius in mm d - pipe inner diameter in mm



Production program of SPIROPIPE pipes and strength class

DN (mm)	Material	Connection method	Strength class
300	PP/HDPE	E.F./rubber	SN2 -SN32
400	PP/HDPE	E.F./rubber	SN2 -SN32
500	PP/HDPE	E.F./rubber	SN2 -SN32
600	PP/HDPE	E.F./rubber	SN2 -SN32
700	PP/HDPE	E.F./rubber	SN2 -SN32
800	PP/HDPE	E.F./rubber	SN2 -SN32
900	PP/HDPE	E.F./rubber	SN2 -SN32
1000	PP/HDPE	E.F./rubber	SN2 -SN32
1100	PP/HDPE	E.F./rubber	SN2 -SN32
1200	PP/HDPE	E.F./rubber	SN2 -SN32
1300	HDPE	E.F.	SN2 -SN32
1400	HDPE	E.F.	SN2 -SN32
1500	HDPE	E.F.	SN2 -SN12
1600	HDPE	E.F.	SN2 -SN12
1800	HDPE	E.F.	SN2 -SN12
2000	HDPE	E.F.	SN2 -SN12
2200	HDPE	E.F.	SN2 -SN12
2400	HDPE	E.F.	SN2 -SN8
2600	HDPE	E.F.	SN2 -SN8
3000	HDPE	E.F.	SN2 -SN8

Types of profiles

PEŠTAN currently offers three basic pipe profile products to its customers:

- PEŠTAN SPIRO PR
- PEŠTAN SPIRO CPR
- PEŠTAN SPIRO OP

Depending on the needs of the project and the desired stiffness, these three profiles can be fur-

ther modified by adding more levels of reinforcement and modification of diameter of the tube. The goal is to complete the optimization of the pipes for the project needs, with full quality guarantee. The capacity of the pipe depends on the spiral steps and by profile type. Independent of payload class pipes (SN2-SN32) or type of internal profile (light) the pipe opening stay unchanged

- PR profile

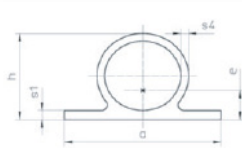
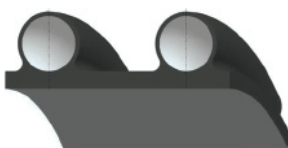

- CPR profile

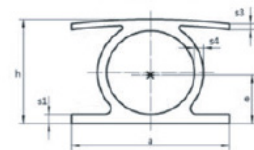

- OP profile

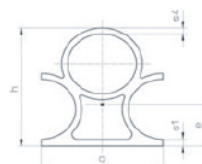

Fittings and shafts

All fittings and shafts are made from the same pipes of which a pipeline is also made. Parts are made in dependence on project needs and customer preference. From the PEŠTAN SPIROPIPE pipes can be made elbows, branches and shafts.

Elbows are made in different angles from 15° up to 90°. Depending on the size of the angle required, it differs and the number of parts that make up the piece.

α	Quantity of segments
15°	2
30°	2
45°	3
60°	3
75°	4
90°	4

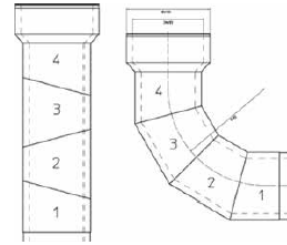

The branches can be oblique and at right angles (T-branches)

Manholes

Manholes production technology allows additional connections of different diameters and at different angles, both horizontally or vertically, in accordance with the project requirements. The manholes are made exclusively according to project specifications and site requirements. The possibility of making manholes in many diameters as and the great options in connection dimensions of manholes, manhole heights and exterior wall options (flat or profiled exterior wall), provide a large number of options to contractors on site. Manholes, also can be straight 3-inlets and tangential. For all additional information, contact PEŠTAN Technical Support or Field sales representative.

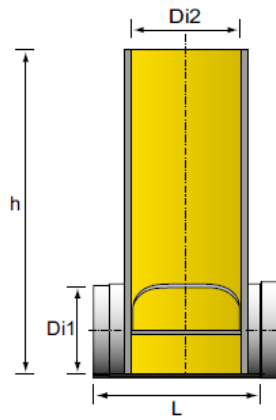
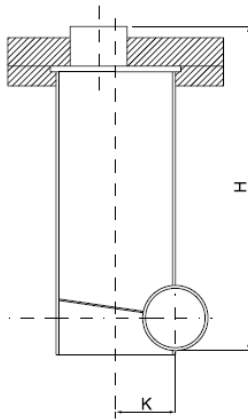

KGF piece

A special KGF conductor is used to connect the pipes with concrete manholes or other concrete structures, different dimensions. The sealing between KGF piece and pipes is done with the rubber gasket, which is supplied with conductor. The home connection is mechanically connected to the main pipe with 100% leak-proof.

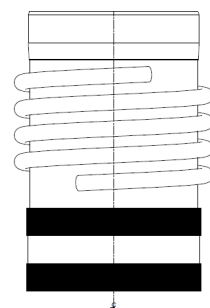
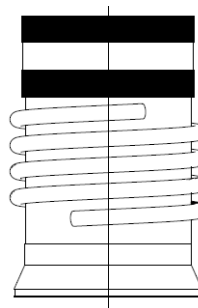



3 TECHNICAL SPECIFICATION

Peštan SPIROPIPE Spiral Tube System is designed for gravity drainage:

- Household water
- Industrial waters
- Rainwater
- Mixed sewage

The internal diameters and hydraulic characteristics of the Peštan SPIROPIPE spiral pipe remain the same over time, regardless of the type of profile, thanks to the greatly reduced roughness and low stickiness of the inner walls of the pipe. The nominal diameter corresponds to the effective inside diameter of the pipe, with tolerances according to the reference norms.

PP spiral pipe connection method

Peštan PP SPIROPIPE spiral pipes are connected only through a socket in which a rubber band made of EPDM rubber is mounted, which means that, unlike PE Spiropipe, they cannot be connected by electrofusion. The physicochemical and chemical properties of polypropylene, as a material, do not allow electrofusion welding, so for this reason these tubes are connected only through the hose and eraser. This type of joint is most widely used because of its simplicity and speed of execution. A rubber band was inserted at the female end of the pipe during production and was homogeneously connected to the sleeve. Then a sliding agent is applied on the inside of the female part and on the seal, which facilitates the pressing of the male part to the stop. The male and female part of the joint is made in accordance with the parameters provided by the standard EN 13476. The rubber is made in accordance with the standard EN 681-1..

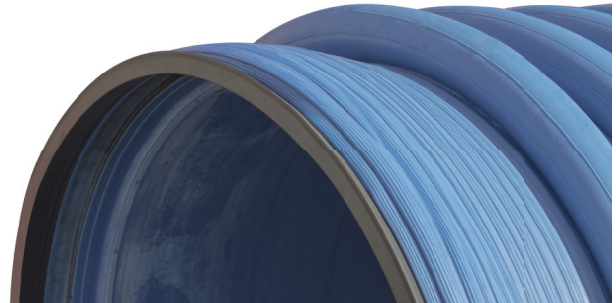

Connecting pipes through socket with rubber band

PE spiral pipe connection method

Peštan PE SPIROPIPE spiral pipes are connected in two ways. Smaller diameters (from Ø300 to Ø1200) are connected via a socket in which a rubber band made of EPDM rubber is mounted or by electrofusion welding. Connection via socket and rubber is the most widespread due to its simplicity and speed of execution. A rubber band was inserted at the female end of the pipe during production and was homogeneously connected to the sleeve. Then on the inside of the female part is applied a lubricant that facilitates injection of the male to stop. The male

Conection of the SPIROPIPES made of polypropilene PP (DIAMETERS)	
SOCKET AND RUBBER	ELECTROFUSION
300	x
400	x
500	x
600	x
700	x
800	x
900	x
1000	x
1200	x

and female parts of the joint shall be made in accordance with the parameters prescribed by EN 13476. The rubber band is manufactured in accordance with EN 681-1.



Connecting pipes through socket with rubber band

Larger diameters are joined by electrofusion welding. The electrofusion welding procedure is described in the following section of this catalog.

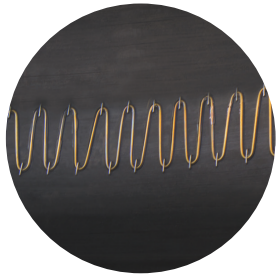

Electrofusion pipe connection

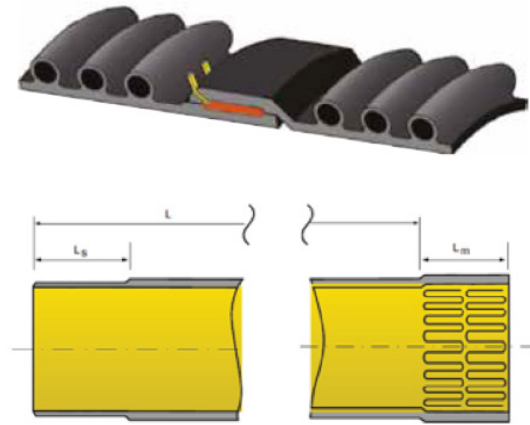

Connection of SPIROPIPE pipes from polyethylene PE (DM)	
SOCKET AND RUBBER	ELECTROFUSION
300	300
400	400
500	500
600	600
700	700
800	800
900	900
1000	1000
1100	1100
1200	1200

Connection of SPIROPIPE pipes from polyethylene PE (DM)	
SOCKET AND RUBBER	ELECTROFUSION
x	1300
x	1400
x	1500
x	1600
x	1800
x	2000
x	2200
x	2400
x	2500
x	2600
x	2800
x	3000

"SPIROPIPE" PIPE WELDING PROCEDURE

Description of the procedure

Peštan spirally corrugated HDPE pipes, intended for electrofusion connection, are delivered to the construction site with a previously installed electrofusion connection. Pipes come protected from dust and moisture in all vital segments. Protection of the tubes should not be removed immediately prior to installation in order to protect the sensitive element of critical for the quality of the compound.

After placing the pipe at the welding location, the protection is removed and a visual inspection of the coupling, installation of the heater in the coupling and the pipe sleeve is performed. Any defects in transport are removed on site if possible, and if not, the pipe is returned to the manufacturer. After that, the couplings on the inside and the pipe sleeve on the outside are cleaned. The cleanliness of the joint and the absence of any moisture on the joint are very important for the quality and water tightness of the joint. Cleaning is done

with materials that do not leave marks on the pipe, such as pieces of paper, cloth and the like. Any grease can also be removed by rapidly evaporating solvents such as isopropyl alcohol or the like. Before continuing welding, it is necessary to make sure that the surfaces are dry otherwise a short circuit on the heater is possible during the welding process.

After cleaning, the pipe is joined by carefully inserting the sleeve into the socket. This operation must be approached carefully due to the possibility of damage to the heater. The wires used to connect the heater to the welding machine should be left on top for easier access. Both pipes must be firmly connected to each other with suitable tensioners. During this process it is necessary to keep track and take care of straightening, on all axes. After welding and cooling the process is complete and correction is almost impossible.



When the pipes are connected and aligned on all diameters larger than 800 mm, it is necessary for a person to enter the pipe and place a ring on the inside at the joint that prevents deformation on the inside. This ring is placed and crucified as much as possible. It is very important that this ring is located just below the location of the tensioning chain on the outside.

The next step is to place the tensioning chain in the channel provided for that purpose, buried on the outside of the coupling. This chain is tightened and after that it is possible to start the process of electrofusion welding.

Welding machine programmed to type, type and diameter of the pipes connecting to the power supply and the electrodes are connected to the wire heater installed in the pipe sleeves. After the start of the process, the welder automatically checks the outside temperature, the resistance of the heater, the set parameters and on this basis starts the welding process or stops it and signals an error. The welder automatically counts down the welding time corrected for a certain coefficient depending on the outside temperature. Immediately before the end of the

welding process, it is desirable to additionally tighten (expand) the inner support and additionally tighten the outer tensioner in order to better connect the material in the now melted part of the sleeve and the sleeve.

However, this should not be exaggerated as it may short the heater and break the weld. The next stage in this process is the cooling of the joint. The complete cooling process, depending on the atmospheric conditions and the diameter of the pipe, takes several hours. The internal support and external tensioner should be left on the joint for a minimum of 45 minutes or more. After complete digestion and complete cooling, the compound is mechanically homogeneous and resistant to external influences such as plant roots. As an additional protection measure, it is permissible to apply additional measures of reinforcement of the joint from the inside or outside of the pipeline, for example additional welding by hand extruder or coating with heat shrink film. This is even desirable in situations where the pipeline is in difficult operating conditions, for example with high groundwater and in soil that is not completely stable such as in alluvial and induction planes.

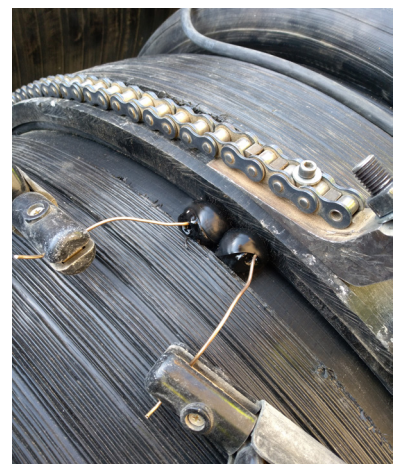
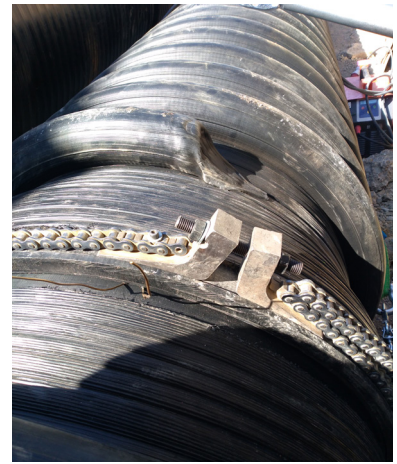

DN/ID [mm]	Voltage [V]	Welding time in seconds at 20 °C to 15 °C	Number of welding machines
300	15	780	1
400	18	840	1
500	20	900	1
600	24	1020	1
700	25	1080 do 1120	1
900	38	900 do 945	1
1100	41	1100 do 1155	1
1200	43	1200 do 1260	1
1300	46	1300 do 1430	1
1400	47	1400 do 1500	1
1500	48	1800 do 1850	1
1600	48	1950 do 2100	1
1600	32	1000 do 1050	1
1800	40	880 do 930	1
2000	39	1100 do 1155	1
2200	44	1380 do 1435	1
2500	45	1300 do 1450	1
3000	Welding voltage and time available on request		

Necessary conditions

In order for the digestion process to be performed properly, it is necessary to comply with certain conditions.

1. Power supply: the unit must be of sufficient power to provide the required energy for the welder, depending on the diameter of the pipeline.
2. Pipe welding must be entrusted to trained personnel.
3. Welded surfaces must be clean, completely dry and protected from direct sunlight.
4. It is not recommended to perform the welding process at temperatures below +5 °C. If necessary, it must be ensured that the process is carried out under a tent, using heaters that can provide homogeneous temperature conditioning of the welded pipe for possible damage to the transport.
5. Proveriti muf i tuljak zbog mogućih oštećenja u transportu.
6. Remove the protective foil immediately before welding and when everything else is ready for use.
7. Connect the pipes so that the heater contact wires are easily accessible.
8. The coupling and sleeve must be thoroughly cleaned with means that do not leave any residue on the pipe or heater.
9. Mark the sleeve with a waterproof marker to the depth that must enter the sleeve. It is not less than 120 mm depending on the type and diameter of the pipe.
10. Connect the tubes and secure them one by one with the spanner and the hammer. Make sure that the sleeve is inserted as needed and that there is no moisture between the sleeve and the sleeve. If moisture is present, stop the process until the conditions are dry.
11. On pipes larger than 800 mm in diameter, place the inner support in the pipe exactly where the tensioning chain comes from the outside.



12. Place the external tensioning chain in the duct on the socket intended for this purpose and tighten it as much as possible. While tightening, make sure that the heater wires are free and away from the chain.
13. After preparation, start welding immediately. Do not take a break at this time because the conditions can easily change.
14. In the case of a short pipeline, make sure that the complete pipeline is fixed and that it will not move any pipe during welding.
15. Connect the welding machine to the heater wires. If the wires are too long, shorten them to avoid any short circuit during welding. If a short circuit does occur, remember the time that has elapsed. Cancel the cycle on the welding machine and start a new cycle but interrupt it after the time required for cycle completion.
16. Enter the parameters in the welding machine.
17. At the very end of the cycle, retighten the inner support and tighten the outer chain as much as possible.
18. When the welding time has elapsed, mark it with a waterproof marker. Enter the number of welds, amperage / voltage which you used, the time and the name of the operator.
19. Remove the welder connections from the heater.
20. Do not move the tubes during the cooling period.
21. After the cooling time has elapsed but not before 45 minutes has elapsed, remove the inner support and outer tensioning chain.
22. Inspection and testing of pipelines are performed according to EN 1610: 200.

SPIROPIPE tightness test pipes made by the air test method

Test equipment:

- Air compressor with petrol or electric motor with pneumatic hoses.
- Calibrated pressure gauge for measuring pressure.
- Balloons for testing of appropriate diameters.



Balloons for testing the tightness of SPIROPIPE pipes

Description of the test method

When testing the tightness of pipelines by the method of air tests according to EN1610, first it is necessary to check all the equipment used during testing. After determining the diameter of the pipeline being tested, by balloons of appropriate diameter, the pipeline is sealed between the two revisions shaft. One of the two balloons is a sealing balloon that has the purpose of clogging the pipeline at one end and preventing leaks, and the other balloon is the so-called transition balloon that serves to be at the opposite end of the pipeline perform clogging of the pipeline and get through it (through a non-return valve) the air into the pump piping system. Balloons are mounted on the ends of the pipeline in between two shafts and inflate to a pressure of 1.8-2.0 bar. Afterward through one of the two balloons (passing balloon) pumps air into the system up to a pressure of 0.2 bar (according to EN1610). After stabilization of the pipeline which lasts about 5 min, if there is no pressure drop or it is pressure drop less than 10%, it can be said that the pipeline impermeable and that the pipeline meets the requirements standard. If a greater pressure loss occurs of 10%, it is necessary to check all connections on the route of the pipeline under test, reseal Balloons for testing the tightness

of SPIROPIPE pipes is or eventual repair of joints on the appropriate route, or even replace a particular pipe if found that the pipe itself was damaged during manipulation and installation, and then perform re-examination. Repeat the previous procedure until the pipeline meets the requirements of the standard by the issue of tightness.

Laying pipes in the trench

A pipeline made of Peštan PP and PE pipes has been installed and tested in accordance with EN 1610 and will provide long-lasting and reliable function in almost all conditions. If there is a special regulation within certain countries, which deviates from the mentioned norm, it is obligatorily to consult Peštan technical support before installation of the system itself.

Trench excavation

Regarding the minimum required trench width (according to measurements and laying depths) should be equal to regulations for the laying of waste water pipes 1610). It should be noted that too narrow channel is harmful for proper installation (settling / compression of the area water), and too wide a channel increases costs so both result are harmful for the system. In the area of the joint of the two pipes should form a recess in the soil so that the ore would not rest on solid ground and so there would not be a load on that point.

Trench width

The width of the trench should allow for proper laying and compaction of the filling material. The smallest width in between pipes and slopes of the trench is $b_{min} = 30$ cm. Minimum width trench (B) at the top of the pipe is:

$$B = D + (2 \times b_{min})$$

If the soil stiffness in the natural state is less than stiffness of the project fulfillment, then width is required trench B is equal to:

$$B1 \geq 4 \times DN$$

In general, these conditions apply to pipes with a diameter of $DN > 250$, because for pipes of smaller diameter the width of the trench (B) satisfies these conditions.

Required material for backfilling and achieving the desired setting angle

The height of the backfill material required to achieve the desired angle of inclination can be calculated according to the following formula:

$$h_{2\alpha} = 0.1 \frac{D_{spolj}}{2} \left[1 - \sin \left(\frac{\pi (180 - 2\alpha)}{360} \right) \right]$$

where is:

$h_{2\alpha}$ – required backfill material to achieve desired setting angle [cm];

D_{spolj} – outer diameter of the pipe [mm];

2α – angle of inclination: 60°, 90°, 120° or 180°.

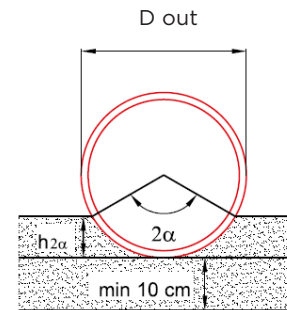

Substrate characteristics

The most important condition for achieving a satisfactory installation pipe systems is the interaction of the pipe and the surrounding soil. The ground around the bottom gives the greatest support to the built-in pipe halves of the pipe in both directions. That is why it is exceptional it is important on which type of soil the laying is performed as well as the procedure which compacts the soil in the area around the pipe. Regarding above mentioned, in any pipe installation the system designer is obliged to determine the conditions for laying pipes such as:

1. soil properties and convenience of local application placenta soil;
2. geotechnical properties of the soil for the placenta, lateral and a top of the embankment, as well as the manner of their installation;
3. appropriate pipe strength class.

The first step in designing sewer systems are geotechnical exploration works along the entire pipeline route. Preliminary field and laboratory are required tests, in order to obtain the necessary parameters soil, such as soil type and its structure, granulometric composition, volume and groundwater level.



Pipe laying depends on geotechnical characteristics soil in the area of pipe installation. In general, there are two ways to lay pipes:

1. Laying on the natural - unprepared soil;
2. Laying on the base layer (placenta) of special material that is compacted to the required levels.

Laying on natural soil

In some cases, pipe laying is possible at the bottom of the trench, but only in incoherent dry soils not containing larger stones (> 20 mm) as which is gravel, coarse sand, fine sand and sand clay. In such soils, the pipe is laid directly on a thin (10-15 cm) uncompacted leveling layer. The purpose of the leveling layer is to raise the bottom of the trench to the required elevation and required fall, and to secure stable and uniform fit of the pipe to an angle from $\alpha = 60^\circ - 180^\circ$.

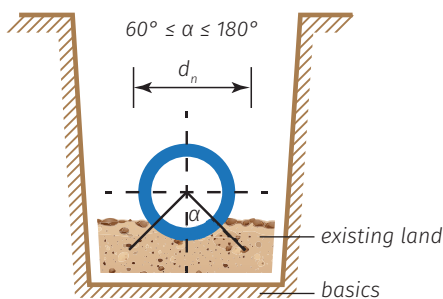

Laying pipes on natural soil

Laying on the placenta

Laying on the placenta should be performed in the case of:

1. when the bottom is in acceptable natural conditions trench mistakenly dug deeper than the project predicted pipe installation depths;
2. rocky, cohesive (clay) and silted soils;
3. poorly bearing soils, such as organic sludge and peat;
4. in all other cases where it is by project provided.

The pipeline is laid in two layers of sand and gravel material with a maximum grain size of 20 mm.

- The base layer is made of well-compacted material in a thickness of 25 cm (minimum 15 cm).
- The leveling layer is 10 to 15 cm thick, uncompacted.

In poorly bearing soils, depending on the thickness of the poorly bearing soil layer below the projected level of the pipeline, possible is the application of two solutions:

1. Where the thickness of the poorly bearing layer is < 1.0 m. In this case, a poorly bearing soil is dug and a trench is filled with a well-compacted layer of the mixture crushed stone and sand (ratio 10: 3). Basic the layer is placed on a geotextile.
2. Where the thickness of the poorly bearing layer is > 1.0 m. In this case a base layer of 25 cm is made well-compacted mixtures of crushed stone and sand (ratio 1: 0.3). Geotextile placement is preferred.

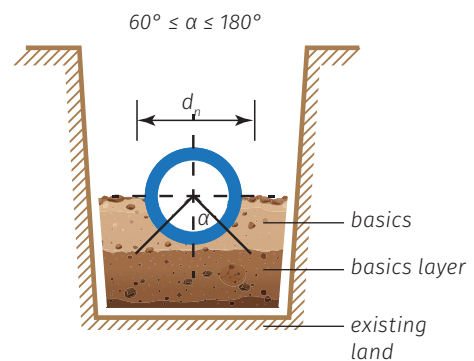

Example of laying on well-bearing soil

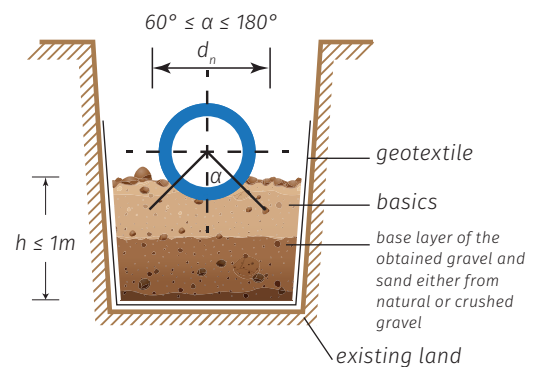

Example of laying on poorly bearing soil with a thickness of ≤ 1.0 m

In all cases for the base coat it is necessary to execute compaction from 85 to 90% according to the modified Proctor's density experiment. With proper foundation and leveling to achieve Proper pipe installation is an equally important class and the installation density of the material at the lateral and above the apex burying.

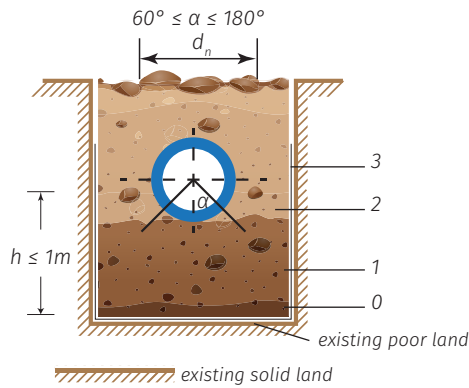

Example of installation on weak soil thickness >1.0m

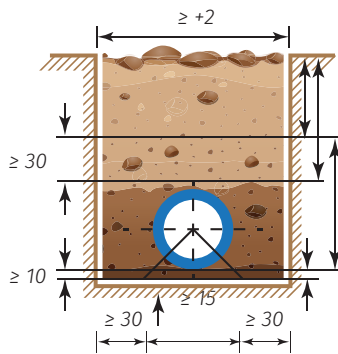

The cross section of the trench

Criteria for selecting suitable material for lateral and over foundation burial is based on achievement required soil strength after compaction. Suitable materials include broadly graded, naturally granular materials, with the largest grain not exceeding 10% of the nominal diameter of the pipe or 60 mm, where is authoritative lower value. Backfill material should not contain snow, ice or frozen lumps of earth.

Material	Particle diameter [mm]	Note
Gravel, broken stone	8 - 22, 4 - 16 8 - 12, 4 - 8	the most suitable material, maximum 5 to 20% 2 mm particles
Gravel	2 - 20	suitable material, maximum 5 to 20% 0.2 mm particle
Sand, fine gravel	0.2 - 20	partially suitable material, maximum 5% particle of 0.02 mm

Table: Properties of backfill material

Degree of compaction

The degree of compaction required depends on the conditions loads.

- For traffic areas min. soil compaction in the zone of the tube is 90% according to the modified Proctor density test.

- Outside of busy areas, compactness is required
- fulfillment from:
 - 85 % according to Proctor's experiment if top layer thickness is > 4.0 m;
 - 90 % according to Proctor's experiment if top layer thickness is <4.0 m.

If the degree of compaction according to the modified is required Proctor of 85%, then:

- compaction is done in layers 0.2 m thick with vibro machines (weighing 50-100 kg) with compaction with both side pipes;
- it is further done in layers 0.15 m thick with vibro machines (weight 50-100 kg), recommended to the minimum height of the compacted layer in this way will be 0.30 m;
- then further done in layers of thickness 0.20 m using a vibro machine (weight 100-200 kg), it is recommended to keep the minimum height like this the compacted layer will be 0.40 m;
- the final layer 0.10 m thick is compacted with the feet.

If the degree of compaction according to the modified is required Proctor of 90%, then:

- compaction is done in layers 0.2 m thick with vibro machines (weighing 50-100 kg) with compaction with both side pipes;
- it is further done in layers 0.15 m thick with vibro machines (weight 50-100 kg), recommended to the minimum height of the compacted layer in this way will be 0.30 m;
- then further performed in layers of thickness 0.20 m using a vibro machine (weight 100-200 kg), it is recommended to keep the minimum height like this the compacted layer will be 0.40 m;
- the final layer 0.30 m thick is compacted with the feet, in three layer of 0.10 m each..

The filling material must be compacted in layers of thickness from 10 to 30 cm. Required thickness of over foundation burial amounts to:

- Minimum 15 cm for pipes with diameter $D_n > 400$;
- Minimum 30 cm for pipes of diameter $D_n < 400$.

Main burial

Material can be used for the main backfill from excavation if it is suitable to achieve the required compactness and if its maximum grain is less than 300 mm. For pipelines with a diameter of $DN < 400$ and with a dark top by backfilling 15 cm thick, the mate-



rial of the main the backfill must not contain grains larger in size of 60 mm. For traffic areas, the minimum tightness of the tight closure is 90% according to modified Proctor density experiment.

Compaction of material

The degree of compaction of the material depending on the conditions of loading and exploitation should be presented in project documentation. Compaction can be done in different ways. It is possible to achieve different degrees of compaction depending on the equipment, layer thickness and compressibility of the material. The table shows the values for gravel and sand materials.

COMPACTION METHODS						
Equipment	Weight (kg)	Maximum thickness (m)		The smallest thickness of backfill above the apex [m]	Number of passes to obtain compaction	
		Gravel, Sand	Loam, clay, sludge		85 % Proctor experiment	90 % Proctor experiment
Wade	-	0.1	-	-	1	3
Manual tamping	min. 15	0.15	0.10	0.30	1	3
Vibrating rammer	50 - 100	0.30	0.20 - 0.25	0.50	1	3
Vibrating board**	50 - 100	0.20	-	0.50	1	4
Vibrating board	50 - 100		-	0.50	1	4
	100 - 200		-	0.40	1	4
	400 - 600		0.20	0.80	1	4

*Before compaction / **in case of both side compaction in relation to the pipe*

Filling and compaction

Backfilling (30 cm above the top of the tube) follows in layers. Up to 1 m of overlay can be used lighter to medium compaction devices. Heavy machinery may only be used afterwards.



4 STANDARDS

STANDARDS THAT APPLIED TO
PE AND PP SPIROPIPE SYSTEM

System PE and PP SPIROPIPE pipes are manufactured and fit requirements of the standard SRPS EN 13476-3: 2008 "Systems plastic pipelines for drainage and sewerage pressureless - Multilayer piping systems non-softened polyvinyl chloride wall (U-PVC), polyethylene (PE) and polypropylene (PP) - Part 3: Specification for pipes and fittings with smooth inte-

rior and profiled outer surface and system, type B " and DIN 16961. It is applicable to existing standards and regulations for the design of sewer systems: 'SRPS EN 752: 2008 Sewage systems outside the building "as well as with standard for pipeline installation "SRPS EN 1610: 2006 Construction and testing of wastewater "lines and channels.

Subject	Standard
Pipe	DIN 16961 EN 13476-1
Static	ATV A 127 ISO 9969
Hydraulics	ATV A110
Pipeline installations	EN 1610
Welding	DVS 2207



5 STORAGE

STORAGE, TRANSPORT AND MANIPULATION
OF PE AND PP SPIROPIPE PIPES

Pipe storage

Prepare a place for disposal (storage) Peštan SPIROPIPE pipes so that the pipes are laid flat (horizontally), without pressing the end of the socket or upside down to prevent deformation. To prevent deformation at the end of the coupling, keep the pipes aligned so that no joints touch another. To prevent contamination of the coupling, make a suitable storage place. Make sure that the pipes cannot move to the left or right. The height of the crimped pipes shall not exceed 4 meter. To guarantee correct welding SPIROPIPE pipes later, before storage must be checked yes the original packaging was not damaged. Pipes are required arrange on a flat surface without stones and sharp objects. If damage has occurred, first muff and sleeve they must check that they are clean and possible dirt rinse with clean water. After that the surfaces are cleaned should be protected with foil. Yes later proper welding it is not compromised, under no circumstances is it a sticky film cannot merge with the outside of the pipe as well as with the inside of the socket (heating wire). Under optimal conditions, if width gaps are placed below the pipe of at least 200 mm, a maximum can be reached beam height of 3 m.

Transport and handling

Peštan SPIROPIPE pipes must be transported with properly transport vehicles. During transport, especially during loading and unloading must be pro-

tected from damage. To prevent deformation at the joints, pay attention during transport so that it does not come to too much pressure at the end of the muff or upright. Before unload pipes check for damage during transport. During unloading of pipes with cranes only belts should be used. It should be avoided steel ropes, chains and elevators with sharp edges. On occasion unloading pipes with a forklift, care should be taken that the forks do not have sharp edges. It is advisable to wrap for example. protective foil around the fork or use the corresponding pipes inside the pipe to be removed. Peštan SPIROPIPE pipes must be loaded and unloaded only by trained staff to prevented damage to the pipes. Before unloading on the face places should check the condition of the pipes. Complaints must be listed on the cargo documents. Pipes of different nominal diameters can be stored into each other if the following conditions are met: Only the pipes in the lowest row can fit into each other, and the difference in diameter of two pipes should be 200 mm.

Note:

When handling and transporting on temperatures below 0 °C, it is necessary to pay special attention to avoid impact stresses, to prevent mechanical damage to the pipes and fittings.

6 ADVANTAGES

ADVANTAGES OF THE PEŠTAN SPIRAL
SPIROPIPE SYSTEM

Durability

Reduced investment costs and expected service life of reduced operating costs for at least 50 years.

Saving time

Significant savings in pipeline installation time can be achieved due to the length and small mass of the pipe, as well as due to easy way of assembly and connection.

Maintenance

Inner smooth sides of the pipe wall, compactness and increased electrical, chemical and biological resistance significantly reduce system cleaning and maintenance costs.

Hydraulics

Due to the increased hydraulic properties it can be used pipes of smaller diameters than traditional pipes.

Watertightness

100 % water tightness of joints: elimination of penetration or fluid leakage as well as root penetration due welded joints.

Lengths

Standard pipe length of 6 m, as well as the possibility making pipes in lengths according to specification, considerably reduce the amount of joints.

Use

Possibilities of using products from the PEŠTAN program SPIRAL SPIROPIPE pipes are numerous. The main application found in the construction of underground sewer networks, but the excellent characteristics of this pipe material make it possible making various systems where fast and easy installation is required, chemical resistance, as well as connection security.



7 USEFUL LINKS

VIDEO: PE SPIROPIPE with electrofusion connection - Production and installation
<https://youtu.be/Vlu5KEBGaNs>



VIDEO: PP SPIROPIPE - Production and installation
<https://youtu.be/Rt94S8t48NU>



WEB: Peštan PE Spiropipe pipes
<https://pestan.net/en/pe-spiropipe/>



PE Spiropipe

PE Spiropipe spiralne cevi su dvostruko korugovane cevi napravljeni od polietilena visoke kvalitete i izrađeni su po najnovijim tehnologijama i koriste najkvalitetnije sirovine. Cevi se proizvode u različitim veličinama i debljinama zidova, a mogu se koristiti za različite namjene. Peštan PE Spiropipe cevi su idealne za korištenje u različitim područjima, a ujednačeno su i jednostavne za instalaciju i održavanje. Peštan PE Spiropipe cevi su idealne za korištenje u različitim područjima, a ujednačeno su i jednostavne za instalaciju i održavanje.

Peštan PE Spiropipe: Travnice, Učiteljski vrtić, DB Daruvar, Hrvatska, Naprednopolje, Duzine i Plovanje.

- PREZENTACIJA
- PROGRAM
- TEHNIČKI
- REFERENCJE
- TUŽIBILNA
- DOVOLJENJE



WEB: Peštan PP Spiropipe pipes
<https://pestan.net/en/pp-spiropipe-2/>



PP Spiropipe

PP Spiropipe spiralne cevi su dvostruko korugovane cevi napravljeni od polipropilena visoke kvalitete i izrađeni su po najnovijim tehnologijama i koriste najkvalitetnije sirovine. Cevi se proizvode u različitim veličinama i debljinama zidova, a mogu se koristiti za različite namjene. Peštan PP Spiropipe cevi su idealne za korištenje u različitim područjima, a ujednačeno su i jednostavne za instalaciju i održavanje. Peštan PP Spiropipe cevi su idealne za korištenje u različitim područjima, a ujednačeno su i jednostavne za instalaciju i održavanje.

Peštan PP Spiropipe: Travnice, Učiteljski vrtić, DB Daruvar, Hrvatska, Naprednopolje, Duzine i Plovanje.

- PREZENTACIJA
- PROGRAM
- TEHNIČKI
- REFERENCJE
- TUŽIBILNA
- DOVOLJENJE



